



GUIDELINES

for Seismic Vulnerability Assessment of

HOSPITALS



Structural Vulnerability

Non-Structural Vulnerability

Functional Vulnerability

Mitigation

GUIDELINES

for Seismic Vulnerability Assessment of

HOSPITALS



World Health Organization (WHO)
Emergency & Humanitarian Action



National Society for Earthquake Technology-Nepal (NSET)

Kathmandu, April 2004

Authors:

Ramesh Guragain
Bishnu Hari Pandey
Surya Narayan Shrestha

Adviser and Reviewer:

Amod Mani Dixit

Language Editor:

Trine Ladegaard

Publisher:

National Society for Earthquake
Technology-Nepal (NSET)

First Publication 2004**Graphic Designer:**

Chandan Dhoj Rana Magar

Book Publication Series:

11

Foreword

It is with great pleasure that I witness the release of this publication, *Guidelines for Seismic Vulnerability Assessment of Hospitals*. It is the latest publication of a series aiming at assessing and reducing the seismic vulnerability, which is so prevalent in many of the hospitals in Nepal.

The guidelines are based on the extensive knowledge gathered in Nepal since the year 2000, when dedicated emergency preparedness planners from Ministry of Health/ Department of Health Services/Epidemiology & Disease Control Division, WHO and National Society for Earthquake Technology – Nepal (NSET) initiated an ambitious programme of assessing the seismic vulnerability of national health facilities.

The starting point was a structural assessment of 14 hospitals in Kathmandu Valley and here acknowledgements must go to the Pan American Health Organisation (PAHO), who was the true pioneer in this field in the Region of the Americas long before the process was started in South-East Asia. We remain grateful for the assistance the assessment process received from PAHO through the structural engineer, Mr. Jaime Argudo, who helped devise the original methodology for carrying out the structural assessment as well as imparted his considerable knowledge and experience to the engineers in NSET.

As a continuation of this, a non-structural assessment of 9 hospitals throughout Nepal was completed by NSET in 2003, and during the course of this assessment, an elaborate methodology had to be developed that took into consideration the specific conditions of health facilities in Nepal.

We are convinced that the methodologies developed are suitable for application not only in Nepal but also in other countries where the conditions of the health infrastructure - building types, available human and material resources and equipment – as well as the seismic risk resemble that of Nepal.

Consequently, it is my belief that the current publication represents a significant step towards assessing and ultimately reducing the seismic vulnerability of the health infrastructure of a range of countries in the South East Asian region.

I would like to extend my appreciation to the WHO South East-Asia Regional Office for their continuous encouragement and assistance as well as to DFID for their financial support without which it would not have been possible to complete this essential task.



Dr. Klaus Wagner
WHO Representative to Nepal

Preface

The Himalayan region lies in an active seismic zone. History of the region is full of devastating earthquakes. Large earthquakes are expected in future also.

Developing countries of the Asia Pacific region witnessed unacceptable levels of damage due to earthquakes in recent years. Of much concern is the fact that health institutions have also been greatly impacted by the earthquakes in terms of death and injuries to health personnel and irreparable damage to the hospital buildings during earthquakes.

Despite this fact, not much of efforts have been done in the developing countries of Asia in terms of either setting of standards or implementation of existing knowledge for ensuring earthquake-resistance of hospital structures and continued functionality of hospital services following an earthquake. The recent earthquake in Bam area of Iran is evidence to this – the earthquake destroyed all the 100 or so health facilities in that city and that the injured were required to be airlifted to the nearest city at a huge cost. While such standards exist for developed countries, there is an obvious lack of simple guidelines for the assessment and reduction of earthquake vulnerabilities of health facilities of developing countries.

The present publication tries to fill this gap as the first step in this direction. This endeavor is based on the experiences gained by NSET in conducting such assessments in the past couple of years in Nepal. The past assessment works were implemented in collaboration with experts from the USA, New Zealand, and the PAHO countries. Such works allowed NSET professionals to augment their theoretical knowledge with the rich practical experiences of improving the seismic performance of health institutions in those seismic countries. It is obvious that continued research is needed for updating and detailing several of the suggestions or guidelines described in this publication in future.

This book is one of the series of such guidelines that NSET aims to prepare and publish for assisting concerned authorities and professionals to safeguard critical facilities and lifelines against earthquakes. Guidelines for Seismic Protection of Educational Buildings has already been published. Guidelines for the assessment of non-structural vulnerabilities of private residences and office buildings are being finalized for publication. NSET will continue these efforts as a part of the long term vision of making communities safer against earthquake in the entire subcontinent.

We are thankful to the Emergency and Humanitarian Action (EHA) of WHO Nepal and also the EHA of South East Asian Regional Office (SEARO) of WHO for their continuous support to Nepal for reducing earthquake risk of her health system. The present work is an outcome of such initiatives. We also thank the Disaster Health Working Group, Epidemiology and Disease Control Division of the Department of Health Services, Ministry of Health of Nepal, for trusting NSET with the task of conducting the surveys, and involving us in the process of earthquake preparedness planning for health sector of Nepal. The government thus provided the much needed policy and organizational framework and suitable environment of trust, which was absolutely necessary for conducting the assessment, and more importantly, translating the experiences gained in the form of these Guidelines.

Sincere acknowledgements are due to Umesh Kattel, Erik Kjaergaard, and Trine Ladegaard of EHA/WHO Nepal for their day to day support while conducting the surveys or during preparation of the reports, and to Dr. Luis J. Perez and Dr. Roderico Ofrin of EHA/WHO SEARO for their constant encouragement and continued support to NSET in developing and implementing the concept of these Guidelines.

Several other Nepalese engineers, from within NSET and outside of it, assisted in the preparation of this book. Prof. Vinod K. Sharma kindly went through the manuscript. We extend our heartfelt gratitude to them all.

Amod Mani Dixit

General Secretary and Executive Director

National Society for Earthquake Technology -Nepal (NSET)

Table of Content

Foreword

Preface

Annexesiii

Table of Figureiv

1	Introduction.....	1
1.1	<i>General</i>	1
1.2	<i>Basis and Scope</i>	1
2	Approaches for Data Collection for Vulnerability Assessment.....	3
2.1	<i>Physical Surveys</i>	3
2.2	<i>Interaction with Hospital Authority and Staff</i>	3
3	Structural Assessment.....	4
3.1	<i>Identification of Building Typology</i>	4
3.2	<i>Selection of Appropriate Fragility Function</i>	5
3.3	<i>Vulnerability Factors Identification</i>	5
3.4	<i>Checking of Stress Conditions of Some Components by Mathematical Calculations</i>	5
3.5	<i>Identifying Probable Influence of the Different Vulnerability Factors on the Seismic Performance of Buildings</i>	6
3.6	<i>Interpretation of the Building Fragility Based on the Surveyed Vulnerability Factors</i>	6
3.7	<i>Making Structural Safety Statement about the Building</i>	7
3.8	<i>Identifying Structural Intervention Options</i>	7
4	Non-Structural Vulnerability Assessment.....	8
4.1	<i>Identifying Critical Systems and Facilities</i>	10
4.2	<i>Assessment of Individual Components</i>	10
4.2.1	<i>Non-Structural Elements</i>	11
4.2.2	<i>Risk Rating</i>	11
4.2.3	<i>Type of Risk</i>	11
4.2.4	<i>Linked Equipment</i>	12
4.2.5	<i>Mitigation Options</i>	12
4.2.6	<i>Implementation Priority</i>	12
4.2.7	<i>Estimated Cost for Implementing Mitigation Options</i>	12
4.3	<i>Assessment of Architectural Nonstructural Components</i>	14
4.4	<i>Assessment of Systems' Vulnerability</i>	14
5	Hospital Performance Evaluation and Recommendations	17
5.1	<i>Performance Evaluation</i>	17

5.2	<i>Comparison with Standard Risk Acceptance Matrix</i>	17
5.3	<i>Recommendations</i>	17
5.4	<i>Expected Performance of the Hospital after Implementation of Recommendations</i>	19
6	References.....	20

Annexes

Annex I:	Checklist for visiting Hospitals	23
Annex II:	Hospital Buildings Typology.....	27
Annex III:	Probable Damage Grade of Different Building Typology.....	33
Annex IV:	Seismic Vulnerability Factors	39
Annex V:	Vulnerability Factors Identification Checklist.....	53
Annex VI:	Quick Checks.....	63
Annex VII:	List of Most Common Equipment in Hospitals	69
Annex VIII:	Rapid Visual Screening References.....	73
Annex IX:	Non-structural Mitigation Options	91
Annex X:	Sample of Non-structural Components Evaluation Sheets	105
Annex XI:	Building Performance Levels	109
Annex XII:	Modified Mercalli Intensity Scale (MMI Scale).....	113
Annex XIII:	Checklist for Assessment of Architectural Non-Structural Components	121

Table of Figure

Figure 1:	Flow Chart for Structural Vulnerability Assessment	4
Figure 2:	Demand for Medical Services after an Earthquake.....	9
Figure 3:	Flowchart for Non-structural Vulnerability Assessment.....	9
Figure 4:	Major Systems of the Hospital.....	10
Figure 5:	Risk Acceptance Matrix.....	17

1 Introduction

1.1 General

This Guideline is for assisting health-sector professionals and authorities to implement qualitative assessments of structural and non-structural earthquake vulnerability of hospitals and health institutions.

The book is based on the experiences gained by the National Society for Earthquake Technology Nepal (NSET) in conducting visual qualitative as well as quantitative assessment of structural and non structural vulnerability of about 20 major hospitals and health institutions of Nepal. The risk assessment was carried out in 2001-2004 under a program implemented by the Disaster Health Working Group of MOH / HMG Nepal with support from WHO-Nepal and the South East Asia Regional Office of WHO (SEARO). The work was discussed among professionals and was subject to critique by national as well as international reviewers.

The experiences gained by NSET in two earlier initiatives also were useful in preparing these Guidelines. The first of these was the seismic performance evaluation of parts of Bir Hospital, Teku Hospital and the Lincoln School that were conducted in cooperation with the Corp of Engineers, US army, in 1999. The other initiative was the joint assessment that NSET undertook with Bir Hospital in collaboration with a group of expert-volunteers from New Zealand in 2000.

During implementation of these two projects it was found that the methodologies developed for such seismic vulnerability assessment work in developed countries cannot be directly applied for developing countries like Nepal. Subsequent work towards development of appropriate methodology for structural and non-structural assessment was done during implementation of these two projects.

Thus, the methodology and approach described in this guideline is based on the experience of NSET in the above mentioned four studies on structural and non-structural vulnerability of hospitals in Nepal.

This guideline is not based so much on fundamental research but rather on adaptation of the different available methodologies to the local conditions of Nepal, and it has been tested that the procedure described here is simple to follow as it provides step by step suggestions of how to carry out assessment.

1.2 Basis and Scope

This publication is mainly targeted to civil engineers and technicians who bear the responsibility of ensuring stability of the hospital building structures and their contents during earthquakes. Engineering consultants responsible for assisting the hospital system in achieving the above mentioned task will also find this book useful. Additionally, hospital authorities and disaster risk managers, who are responsible for hospital emergency preparedness, may also use these Guidelines as a tool for understanding the tasks and directing their implementation.

It should be noted that the results of any structural vulnerability assessment conducted as per these Guidelines could best be used for planning purposes; i.e. largely for identifying the priorities of intervention in hospital systems - the Guidelines' checklists for visual inspection can not replace the need for a detailed structural vulnerability assessment. Similarly, not all the details required for implementing the mitigation measures are provided in the present publication.

However, this Guideline does provide advice on assessment as well as on implementation of non-structural vulnerability reduction measures. Needless to say, that in certain structures the concerned authorities, engineers and managers may have to carry out a more detailed non-structural assessment than outlined here.

It should be borne in mind that the Guidelines are based on the analysis of the types of hospital structures and hospital systems prevalent in Nepal. Similarly, the non-structural components analyzed are only those that are used in 20 or so large-size hospitals of Nepal. While we believe that the survey conditions found in Nepal largely reflect the general structural and non-structural situation of hospital systems in South Asia as well as a large part of the developing countries of the Asia Pacific region, one has to exercise caution when using the Guidelines in other countries.

2 Approaches for Data Collection for Vulnerability Assessment

2.1 Physical Surveys

Acquisition of building data pertaining to the building is the first step in any evaluation. The data should be obtained preferably prior to the initial site visit and confirmed during the visit. Construction documents like as-built drawings and structural shop drawing are required for preliminary evaluation. Site condition and soil data should be collected if possible. However, the structural and construction drawings may not be available prior to visits to hospitals. The drawings may not be available even with the hospitals. When drawings are unavailable or incomplete, all necessary information must be collected from site visits. The general information required from drawings and / or visit concerns building dimension, construction age, structural system description (framing, lateral load resisting system, diaphragm system, basement and foundation system).

During visits, it may be required to investigate the interior of the structural members. In many buildings the structure is concealed by architectural finishes, and the inspector may need to get into attics, crawl spaces, and plenums to investigate. Some intrusive testing may be necessary to determine material quality and allowable stresses. Even if structural drawings are available, some exposure of critical reinforcement may be necessary to verify conformity with the drawings. Photographs of building exterior and interiors may also be useful for the evaluation. For a qualitative assessment, the minimum information required for evaluation is given in **Annex-I**.

The evaluation should be based on facts as opposed to assumptions, to the greatest extent possible. However, prudent engineering judgment may avoid the huge efforts and cost a detailed investigation requires.

2.2 Interaction with Hospital Authority and Staff

Generally, it is difficult to obtain as-built or design drawings for most hospitals. Therefore it is necessary to interact with hospital authorities and other staff for the assessment of hospitals. It is also necessary to involve them in the process to get their buy-in on the outcome of the hospital assessment and, more importantly, on the proposed mitigation actions. This approach will also help in sensitizing authorities and raising awareness of hospital staff on seismic safety issues. This is very important as there is general lack of awareness and commitment. In addition, the hospital doctors and maintenance staff themselves are in the best position to identify the problems and recommend feasible solutions for the local context, which is required for developing appropriate mitigation options. Thus, the approach with the following considerations is suggested for effective evaluation as it induces the development and implementation of doable mitigation actions.

- The assessment shall not solely rely on secondary information but involve primary data collection and confirmation of available information with the active participation of hospital staff. The hospital staff shall also be involved in the process of identification of mitigation actions.
- The choice of non-structural mitigation measures shall be made based on availability of materials / tools and local capacity to implement.
- The assessment work shall be considered as an awareness and education tool to promote overall safety of the hospital as well as the collective safety of the personnel.

3 Structural Assessment

As the building structure houses all facilities of the hospital, its performance during an earthquake governs all functions of the hospital system. The structure serves as a skeleton analogous to the role of the bones of the human body. It supports the equipment, utilities and other non-structural components like partition walls, parapets, false ceilings, windows etc. Doing a structural assessment refers to the estimation of the performance level of the structural system when subjected to earthquake loads of different intensities. The performance of the system depends on the structural characteristics of individual members and their interrelationship. The structural members include foundations, columns, supporting walls, beams, floor slabs and any other elements with direct participation in the load carrying system of the buildings. The structural performance of hospitals in an earthquake is measured in terms of vulnerability. The vulnerability of the structure is the susceptibility of those members to damage at local level as well as its consequences for the stability of the building system when subjected to earthquake load.

The analysis procedure of qualitative seismic vulnerability assessment comprises of identifying structural characteristics, analyzing their inter-relationship in regard to earthquake action and determining the fragility. The procedure is presented in figure 1 and outlined in the following sections.

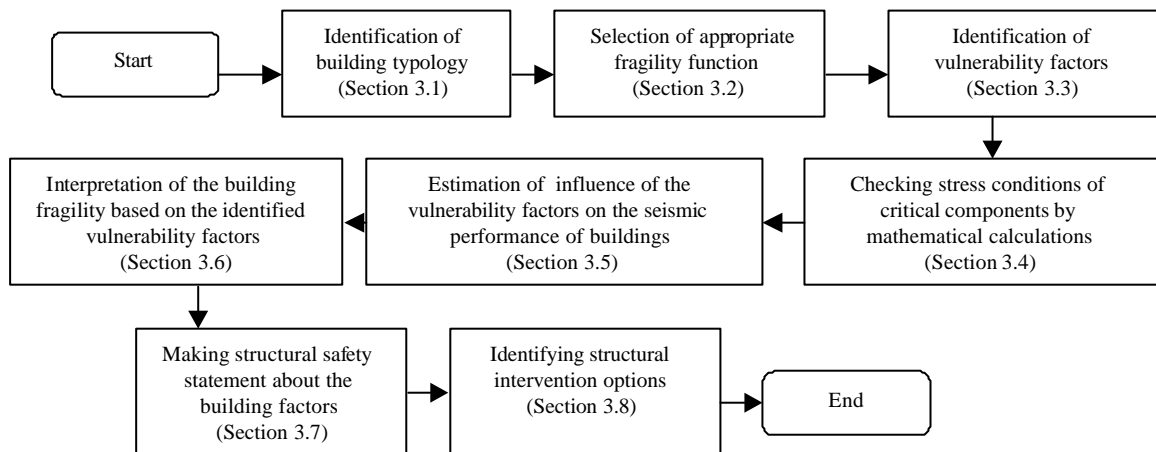

Figure 1: Flow Chart for Structural Vulnerability Assessment

3.1 Identification of Building Typology

The first step of structural assessment is classification of the building type. The typology should be assigned in a broader sense to one of the type listed below. The basic parameters of building categorization are lateral force resisting system, materials used, building height and the floor diaphragm. These parameters are applicable for observed buildings systems of hospitals in Nepal. Most of these typologies are defined in the Nepal National Building Code document, BCDP [1], which also gives the seismic fragility of those building types. However, some additional typologies are given here in this guideline to cover common types of building systems used by hospitals. The detailed explanations of different types of building systems used for hospitals in Nepal are given in **Annex-II**.

As most structures are unique and may not satisfy the parameters of a single building typology as defined, judgment may be required when classifying systems according to their particular type. The lateral force resisting system should be taken into account as a primary parameter in such categorization.

The hospital buildings under evaluation might fall in one of the types below:

- Type 1: Adobe, stone, adobe & stone, stone & brick-in-mud.
- Type 2: Un-reinforced masonry made of brick in lime, brick in cement, and well-built brick in mud, stone in cement
- Type 3: Reinforced concrete ordinary-moment-resistant-frames (OMRF)
 - A: OMRF with more than three stories
 - B: OMRF less or equal to three stories
- Type 4: Reinforced concrete intermediate-moment-resistant-frames (IMRF)
- Type 5: Reinforced concrete special-moment-resistant-frames (SMRF)
- Type 6: Other (must be specified and described)

3.2 Selection of Appropriate Fragility Function

The fragility function, which describes the level of damage to a particular building type under different levels of earthquake intensity, must be selected to the hospital building in question. These fragility functions are presented in **Annex-III**.

The fragility functions presented in this guideline are derived from the scale described in *The Development of Alternative Building Materials and Technologies for Nepal: Seismic Vulnerability Analysis* (Appendix-C) and *European Macro-seismic Scale*, 1998, which take into account the damage extent to both structural and non-structural elements of similar buildings in past earthquakes.

3.3 Vulnerability Factors Identification

The building specific parameters which influence the overall seismic performance of the building system shall be determined from visual observation and desk study. The items to be checked for this purpose are regarded as *vulnerability factors* in this guideline. The vulnerability factors and their detailed description including the extent of their influence on building performance in earthquake loading are presented in **Annex IV**. For each building type mentioned earlier, the applicable set of general vulnerability factors are presented in the form of checklists in **Annex-V**. The checklists provide statements to be judged against the building in relation to the vulnerability factors. The details and references to each item are provided in **Annex IV**. The checklist pertaining to the typology in which the building to be assessed falls shall be filled out as compliance "C", non-compliance "NC" and not applicable "NA" to each of the statements relating to vulnerability factors against the building. Engineering judgment is required to fill out the checklist. Knowledge of site-specific geological hazards, building forms, the lateral force resisting system, member connections, diaphragms and non-structural hazards is required for the judgment and analysis. The best option for performing this task is to carry out the analysis on site with input from visual observation of buildings and site conditions. Depending on the building and site condition, statements pertaining to some vulnerability factors may not be possible without calculations. During the site visit, those items of the checklist shall be marked and the necessary detailed data required for analysis through calculations shall be acquired.

3.4 Checking of Stress Conditions of Some Components by Mathematical Calculations

The items of the checklist that could not be judged by simple visual observations during the site visit shall be analyzed by quick calculations. Though not rigorous, the analysis gives very important information on the status of the building in possible earthquake events. These checks are generally meant for checking for stress conditions of critical members that are likely to happen due to special configurations and the construction of the building. Examples of such items are quick shear checks of walls and columns of the ground storey, check for strong column-weak beam conditions, and shear stress check in columns where short-column

condition is prevailing, check for soft-story effect etc. Some example calculations are given in **Annex-VI** for reference.

3.5 Identifying Probable Influence of the Different Vulnerability Factors on the Seismic Performance of Buildings

Based on the severity of vulnerability factors as observed and put in the checklist during site visits and analyzed by quick checks, possible effects of the vulnerability factors on the target building shall be identified on relative scale. The scale is in terms of increment in vulnerability and termed as *high*, *medium*, *low*, *not applicable* and *unknown*. Prudent engineering judgment is necessary for this qualitative analysis. The description of vulnerability factors presented in **Annex-IV** and other literature on past earthquake damage could be useful references for the analysis. Table 1 provides a checklist of the vulnerability factors and the relative scale of severity on building performance.

Table 1: Identifying Probable Influence of the Different Vulnerability Factors on the Seismic Performance of Buildings

Vulnerability Factors		Increasing Vulnerability of the Building by different vulnerability factors				
		High	Medium	Low	N/A	Not known
Building System	Load Path					
	Weak Storey					
	Soft Storey					
	Geometry					
	Vertical Discontinuity					
	Mass					
	Torsion					
	Deterioration of Material					
	Cracks in Infill Wall					
	Cracks in Boundary Columns					
Lateral Force Resisting System	Redundancy					
	Shear Stress Criteria					
Connection	Connectivity between different Structural Elements					
Others	Pounding Effect					

3.6 Interpretation of the Building Fragility Based on the Surveyed Vulnerability Factors

The fragility function described in section 3.2 for a particular typology of building shall be further refined based on the information derived in section 3.5 above. The refinements will be in terms of *weak*, *average* and *good*. As the analysis described here is qualitative, the refinement must be made from judgment, based on the relative scale of the vulnerability increment as obtained in section 3.5. For instance, the refinement will be "weak" if more than

one vulnerability factor of the building has "high" influences, or shear stress exceeds the capacity of the wall or column. Here, "average" signifies the expected behavior of that type of building in general whereas "good" means that most of the vulnerability factor influences are either in the category "low" or not applicable.

3.7 Making Structural Safety Statement about the Building

The expected damage to the building at different intensities shall be judged using the damage grade matrix presented in **Annex-III**. The matrix gives statements on building seismic performance based on the typology and building specific vulnerability refinement as *weak*, *average* and *good*. The statements refer to the performance of buildings in terms of the damage grade expected for different levels of earthquake intensity measured in the Modified Mercalli Intensity (MMI) scale. Refer **Annex-XII** for description of the MMI scale. In **Annex-III**, the description of damage grades for different types of buildings is also mentioned. The structural seismic safety statement of the building shall be made using the format shown in Table 2.

Table 2: Structural Safety of the Buildings at Different Intensity Earthquakes

	Performance of the Building			
	MMI VI	MMI VII	MMI VIII	MMI IX
Building#1				

3.8 Identifying Structural Intervention Options

It is not possible to design retrofitting of buildings with the level of assessment described above. However, intervention options for weak buildings, e.g. seismic retrofitting or reconstruction, can be identified based on the performance assessment.

In general, buildings, which are not designed for seismic loads but are good enough in general conditions, are more likely to be suitable for retrofitting. Buildings with several deficiencies and with deteriorated and weak construction materials may need reconstruction.

The cost of retrofitting depends on the condition of existing buildings; the method of retrofitting and the type of construction, but as a preliminary estimate, the tentative cost of retrofitting can be taken as 20-40% of the cost of reconstruction.

The identification of intervention options and preliminary cost estimates described in this step should be used only for planning purposes, as a more detailed retrofitting design is necessary for actual implementation.

4 Non-Structural Vulnerability Assessment

A building may remain standing after an earthquake, but it might be functionless due to nonstructural damage to the equipment, lifeline conduits and other non-structural elements like partition walls, veneers, ceilings, window panes etc. Assessment of non-structural vulnerability is made in order to estimate the expected damage that these elements may suffer when subjected to earthquake shaking at different levels of intensity and the consequence to the functionality of the hospital. The cost of the non-structural elements in a hospital may be much higher than that of the structure. Particularly in hospitals, it may reach up to 90% of the total facility value. Moreover, the susceptibility to non-structural damage would be high even in a moderate level earthquake (MMI VI-VII). This can affect or destroy vital aspects of a hospital including those directly related to its function, without significantly affecting the structural components. Thus, in an earthquake, the external appearance of a hospital might be unaffected, but it may not be able to care for patients if the internal facilities have been damaged.

The desired level of performance of hospital facilities is much higher than that of other utility services because it is imperative that hospitals remain fully functional after an earthquake. Because of the large number of injuries expected, demand for medical services will be very high within the first 24 hours (**Figure 2**). In summary, a non-structural vulnerability assessment and consequent implementation of mitigation measures in hospitals are justified on the following grounds:

1. Hospital facilities must remain as intact as possible after an earthquake due to their role in providing routine medical services as well as attending to the possible increase in demand for medical treatment following an earthquake.
2. In contrast to other types of buildings, hospitals accommodate a large number of patients who, due to their disabilities, are unable to evacuate a building in the event of an earthquake.
3. Hospitals have a complex network of electrical, mechanical and sanitary facilities as well as a significant amount of costly equipment all of which are essential both for the routine operation of the hospital and for emergency care. Failure of these installations due to a seismic event cannot be tolerated in hospitals as this could result in its functional collapse.
4. The ratio of the cost of nonstructural elements to the total cost of the building is much higher in hospitals than in other buildings. In fact, while nonstructural elements represent approximately 60% of the value in housing and office buildings, in hospitals these values range from 85% to 90%, mainly due to the cost of medical equipment and specialized facilities.

This section focuses on the different steps necessary for evaluating the non-structural components of hospitals.

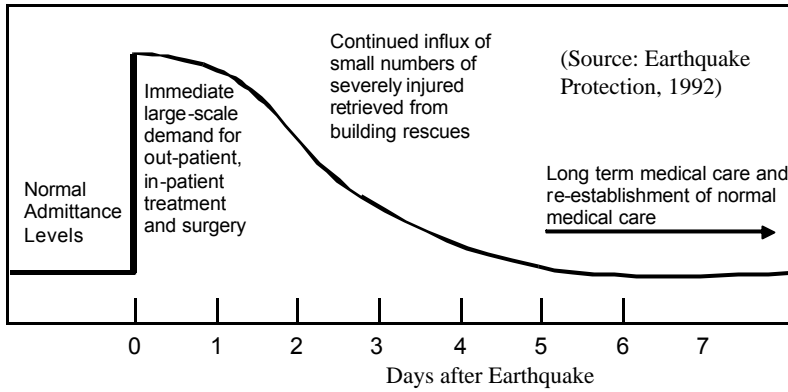

Figure 2: Demand for Medical Services after an Earthquake

The major steps required for implementing the assessment of non-structural vulnerability of hospital systems to earthquakes are shown in the following flowchart (Figure 3).

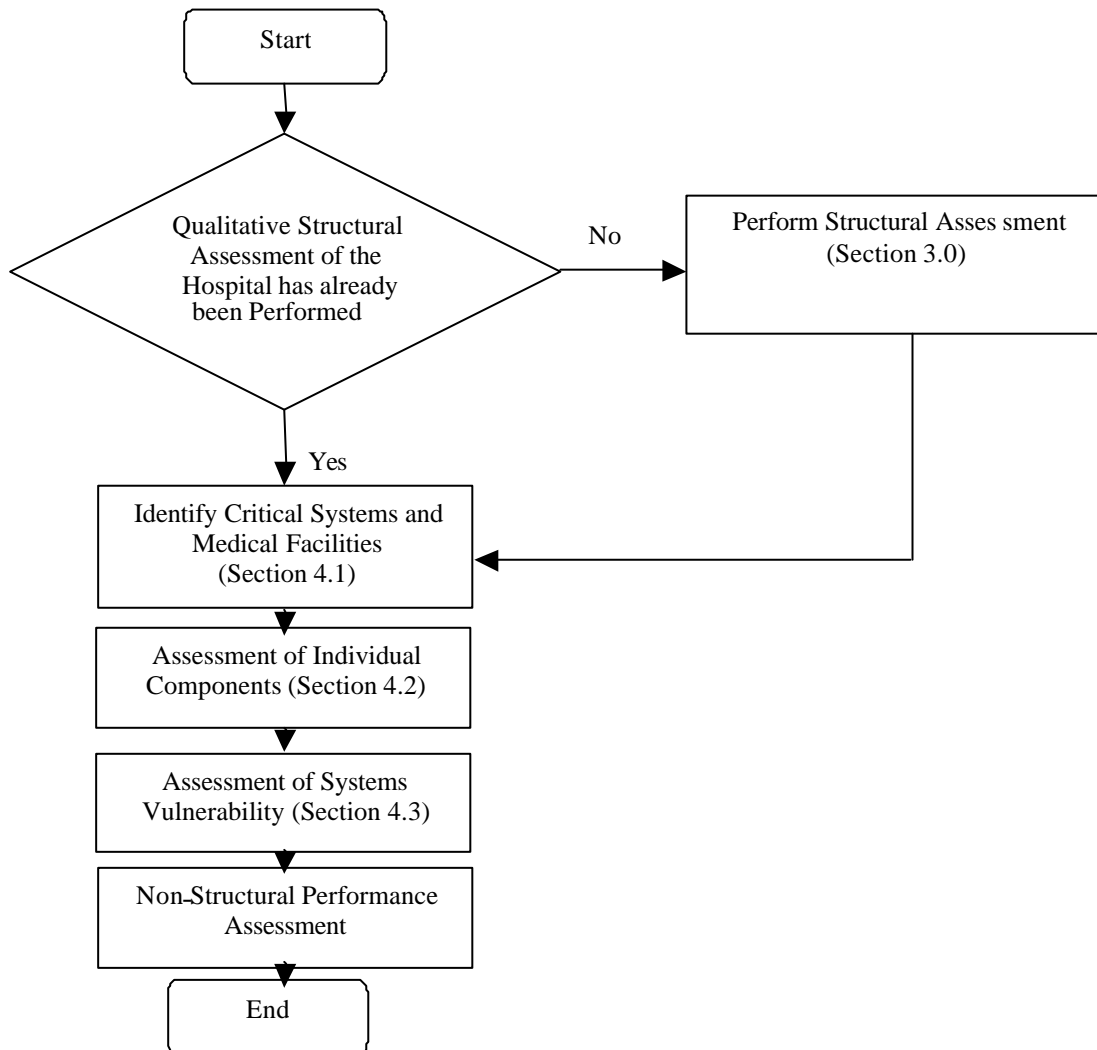

Figure 3: Flowchart for Non-structural Vulnerability Assessment

4.1 Identifying Critical Systems and Facilities

Identification of critical systems and essential facilities of hospitals shall be carried out based upon the functional requirements of the hospital during and after an earthquake. The main critical systems and facilities, which are important for continued functionality, are identified after visiting the hospital.

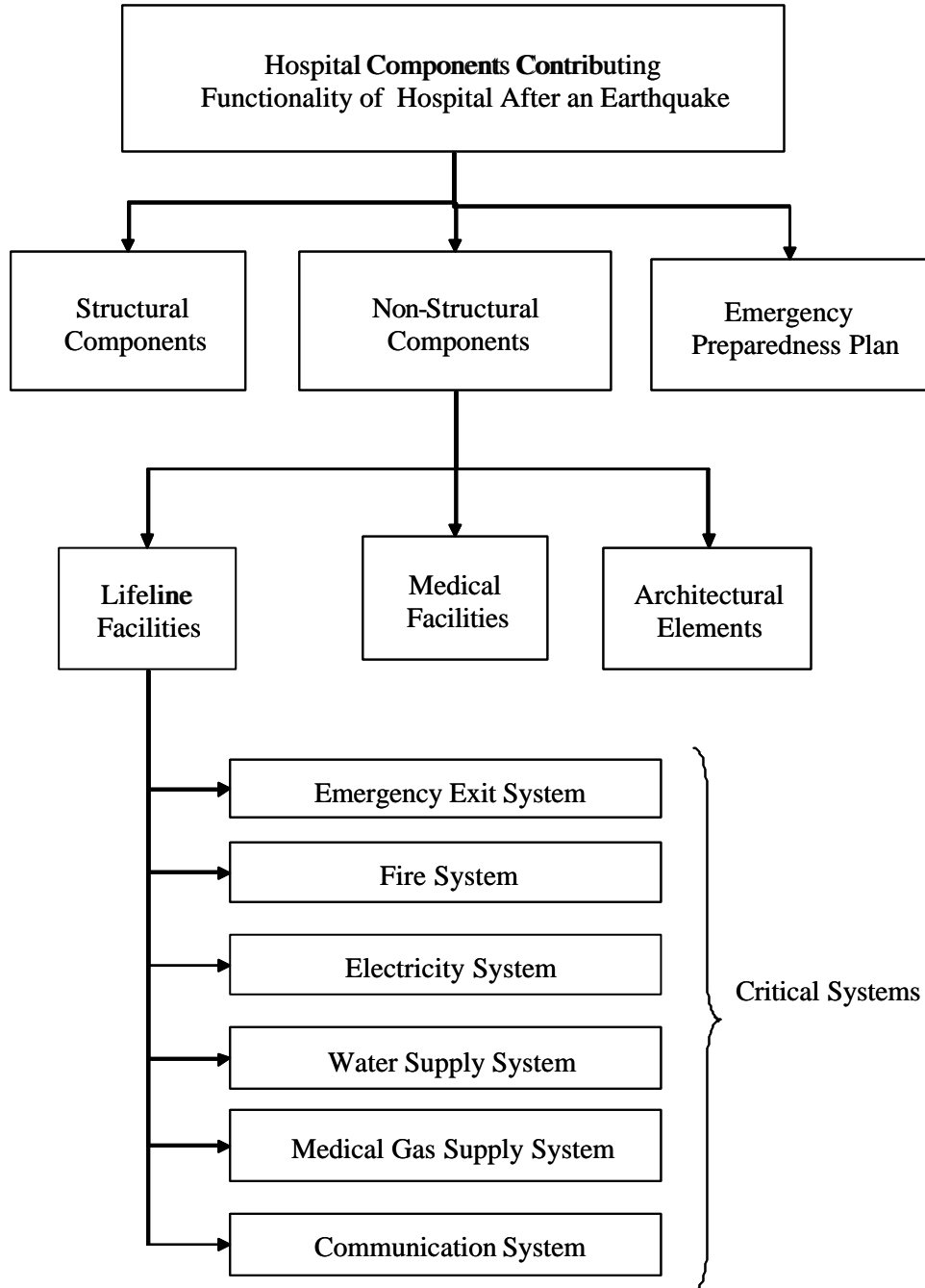

Figure 4: Major Systems of the Hospital

4.2 Assessment of Individual Components

All the components of lifeline systems, medical facilities and architectural elements should be studied on an individual basis. However, it is preferable that the assessment takes place system by system, studying all individual components of a specific system before moving to

the next. The sequence of assessment should be to study lifeline systems first, then equipment in medical facilities and finally furniture and architectural components for observation. All the identified critical systems and facilities shall be visited to evaluate the vulnerability of the individual components. All equipment and components shall be rated against two levels of earthquakes, i.e. a medium size earthquake (MMI VI-VII) and a severe earthquake (MMI VIII-IX), in terms of different levels of damage; very high, high, medium and low. Vulnerability reduction options, implementation priority and cost estimation for implementation of mitigation options should be identified for all equipment and contents. **Table 3** provides a format for assessment of individual components. Sample non-structural assessment sheets for critical systems and medical facilities are given in **Annex-X**.

4.2.1 Non-Structural Elements

The term "non-structural" refers to components that are physically joined to a building's structure (including partitions, windows, roofs, doors, and ceilings), those that are essential to the building's functionality (such as plumbing, heating, air conditioning, and electrical connections), and items located within the building (such as medical or mechanical equipment and furniture). Broadly classified, there are three categories of non-structural elements: architectural components, installations, and equipment. The most common equipment in hospitals is listed in **Annex-VII**.

4.2.2 Risk Rating

The risk rating of non-structural components shall be made based on its location in the building and its connection with it, such as anchorage situation, load path, pounding or impact concerns, interaction concerns etc. Risk Rating Reference Sheets are given in **Annex-VIII**.

4.2.3 Type of Risk

For the assessment of each component, the risk associated with earthquake damage to it shall be identified in terms of life-safety, property loss, and interruption or loss of essential functions. Damage to any particular non-structural item may pose differing degrees of risk in each of these three categories. In addition, damage to the item may result in direct injury or loss, or the injury or loss may be the secondary effect or consequence of the failure of the item. All equipment shall be rated for one type of risk. In general, individual pieces of equipment pose more than one type of risk. When selecting the type of risk, the priority should be threats to *Life Safety* first, then *Loss of Function* and lastly *Property Loss*. The three types of risk associated with non-structural components are described in the following section.

4.2.3.1 Life Safety

The first type of risk is that people could be injured or killed by damaged or falling non-structural components. Even seemingly innocuous items can be lethal if they fall on an unsuspecting victim. Examples of potentially hazardous non-structural damages that have occurred in past earthquakes include broken glass, overturned tall and heavy cabinets or shelves, falling ceilings or overhead light fixtures, ruptured gas lines or other piping containing hazardous materials, damaged friable asbestos materials, falling pieces of decorative work such as brick, stone or marble cladding and falling masonry partition walls and fences.

4.2.3.2 Loss of Function

In addition to the threat to life safety there may be the risk that non-structural damage will make it difficult or impossible to carry out the normal functions of the facility. After the serious life safety threats have been dealt with, the potential for post-earthquake downtime or reduced productivity is usually the most important risk.

4.2.3.3 Property Loss

Contents such as movable partitions, furniture, files and office or medical equipment

represent a significant cost in case of hospitals. Damage to the non-structural elements and contents of a building can be costly since these components account for the vast majority of building costs. Immediate property losses attributable to contents alone are often estimated to be one-third of the total earthquake losses. Property losses may be the result of direct damage to a non-structural item or of a secondary effect. If water pipes, fire sprinklers or their connecting pipelines break, the overall property losses will include the cost of repairing the water damage in the facility. If the gas line to a water-heater ruptures and causes a fire, clearly the property loss is much greater than the cost of a new pipefitting. On the other hand, if many file cabinets overturn and all the contents end up on the floor, the direct damage to the cabinets and documents will probably be negligible (unless they are also affected by water), but employees may spend many hours or days sorting out the documents. If a reserve water tank is situated on the roof of a building, the consequences of damage to it may be more severe than they would be if it were in the basement or outside the building.

4.2.4 *Linked Equipment*

Supporting systems and equipment which needs other components to function must be noted and their inter-linkages shall be studied as the main concern of evaluating individual pieces of equipment is to identify the possibility of the equipment being functional after an earthquake. For example, if the X-ray equipment is being evaluated, the control panel and high voltage transformer shall be studied simultaneously in order to identify the possible functional status of the X-ray machine after an earthquake.

4.2.5 *Mitigation Options*

Once a non-structural element has been identified as a potential threat in terms of loss of lives, of property and / or function, the appropriate measures must be identified to reduce or eliminate the risk. The risk mitigation option might be different for each individual component and should therefore be recommended one by one during the study. The availability of local material and technology shall be considered while making recommendations for mitigation options. Some of the possible mitigation measures are given in **Annex-IX** as a reference.

4.2.6 *Implementation Priority*

Implementation of mitigation options for a particular piece of equipment should be based on its risk rating and type of risk associated with it. If the equipment poses a risk to both life safety and loss of function, the implementation priority should be given as *first*.

4.2.7 *Estimated Cost for Implementing Mitigation Options*

The cost of implementation of mitigation measures for individual pieces of equipment shall be calculated during the assessment, which will help with estimating the total cost required for improving the safety of a system to the desired level. A general outline of cost involvement for implementing different mitigation options is given in **Annex-IX**. Discussing the probable cost involvement with the hospital maintenance staff might prove helpful for a more precise estimation.

Table 3: Individual Components Assessment Format

S.N.	Non-Structural Element	Quantity	Earthquake	Risk Rating	Type of Risk	Location	Linked Equipment	Mitigation Option	Implementation Priority	Estimated Cost for Implementing Mitigation options (US\$)	Remarks
			Moderate								
			Severe								
			Moderate								
			Severe								
			Moderate								
			Severe								
			Moderate								
			Severe								
			Moderate								
			Severe								

Type of Risk

- LS: Life Safety
- LF: Loss of Function
- LP: Property Loss

Risk Rating

- VH: Very High
- H: High
- M: Medium
- L: Low

4.3 Assessment of Architectural Non-Structural Components

Partition walls, window glass panels, parapet walls, cladding and false ceilings are the main architectural non-structural elements, which are most likely to be found in hospitals. Partition walls shall be checked for whether they are reinforced, whether they are detailed to allow sliding and movement at the top and side and for whether they are restrained at the top and sides against falling. Ceilings shall be checked for whether they are diagonally braced or not. Window glass panels shall be checked for plastic lamination. Similarly, for cladding the main concern is the type of nails used and how they have been nailed. Parapet walls shall be checked for their height / thickness ratio and reinforcement. **Annex XIII** gives a checklist for assessment of architectural non-structural elements.

4.4 Assessment of Systems' Vulnerability

Based on the assessment of the individual components of the respective systems, the critical systems and medical facilities shall be examined to find out the possible level of damage in at least two earthquake scenarios. The different levels of potential damage and its consequences for the performance of the individual components and the systems shall be presented in a table like table 5.

Mitigation options for each system shall be identified and critically evaluated in terms of ease and cost of implementation and of their expected efficiency regarding vulnerability reduction.

The feasibility of implementing mitigation options can be defined as either easy to implement or difficult to implement. Similarly, the cost involvement for implementing the mitigation options can be identified as low or high cost involvement. Some criteria can be made to differentiate the feasibility of implementing mitigation options. Considering the financial and manpower capacity of the maintenance division of specific hospitals, one way of defining these terminologies are given below in the box.

Easy to Implement: *The maintenance division of the hospital can implement the mitigation options after a short training from outside. The materials necessary for implementing mitigation options are mostly available at the local market.*

Difficult to Implement: *Experts from outside the hospital are necessary to implement the mitigation options. The materials necessary for implementing mitigation options are not available at the local market.*

Low Cost: *The cost involvement is less than US\$ 2000.00 (The hospital administration / maintenance division can allocate the budget to implement the mitigation option).*

High Cost: *The cost involvement is more than US\$ 2000.00 (The hospital administration / maintenance division can not allocate the budget to implement the mitigation option and needs external financial support.)*

The performance of the hospital in terms of non-structural safety shall be evaluated at four distinct levels of damage. This should be done for each critical system and facility that the hospital contains. The performance levels to be used here are defined in **Table 4**. While assessing the performance level of different critical systems, it is necessary to consider the structural safety of the hospital buildings, where these systems lie. **Table 5** provides a format for evaluating the different critical systems of a hospital.

Table 4: Non-Structural Performance Levels and Damage Descriptions (Adapted from NEHRP Guidelines for the Seismic Rehabilitation of Buildings, FEMA-273)

Performance Levels and Overall Damage	Expected Levels of Damage to the Different Systems		
	Critical Systems / Components	Contents and Equipment of Medical Facilities	Architectural Elements
Operational (Slight Damage)	Lifts operate; ducts and piping sustain negligible damage; the fire response system is functional; transformer / generators are functional and electricity can be provided; water can be provided.	Medical equipment on floors and walls is secure and operable; power is available; equipment on rollers slides but does not tip and does not impact with anything; cupboards, racks cabinets and book shelves do not tip; negligible damage to chemical bottles in the lab; oxygen cylinders and blood stands are not tipped over.	Negligible damage to false ceilings, chimneys, light fixtures and stairs; minor damage to parapets and doors; minor cracks in cladding and partitions.
Immediate Occupancy (Slight to Moderate Damage)	All system components are secured; generators start but may not be adequate to service all power requirements; minor leaks in some joints of water supply pipelines; fire systems and emergency lighting systems are functional; medical gas supply systems are secure and functional if electricity is available, lifts are operable and can be started when power is available.	Medical equipment on floors and walls is secure but power may not be available; some equipment on rollers slides and impacts with something; cupboards, racks cabinets and book shelves do not tip; negligible damage to chemical bottles in the lab; blood stands may tip.	Minor damage to ceilings, chimneys, light fixtures, doors; some window glasses crack; some cracks to partition walls.
Life Safety (Moderate to Heavy Damage)	Lifts out of service, some breakages to pipelines and ducts; some fixtures broken; electrical distribution equipment shifts and may be out of service; breakages in medical supply systems near heavy equipment.	Medical equipment shifts and disconnects from cables but does not overturn; most equipment on rollers slides; some cupboards, racks cabinets and book shelves tip; some damage to chemical bottles in the lab; lab equipment slides from tables.	Extensive cracked glass, some broken glass; severe cracks in partitions and parapets; doors jammed; some fracturing to cladding.
Hazards Reduced Levels (Heavy to Very Heavy Damage)	Some critical systems' equipment slides or overturns; some piping lines rupture; generators will be out of function; some damage to the fire response system.	Equipment rolls, overturns, slides, and cables are disconnected; some equipment requires reconnection and realignment; sensitive equipment may not be functional; cupboards, cabinets and racks overturn and spill contents; severe damage to lab chemicals.	Generally shattered glass and distorted frames; widespread falling hazard; damage to partitions and parapets; severe damage to claddings; extensive damage to light fixtures.

Table 5: Expected Damage to the Hospital and Probable Mitigation Feasibility

Critical Systems and Facilities		Expected Damage and Feasibility of Mitigation Option			
		Moderate Earthquake (MMI VI – MMI VII)		Severe Earthquake (MMI VIII - MMI IX)	
		Predicted Damage	Mitigation Feasibility	Predicted Damage	Mitigation Feasibility
1.	Electricity System				
2.	Water Supply System				
3.	Fire Response System				
4.	Communication System				
Important Departments and Wards	5. CSSD				
	6. X-Ray/Radiology				
	7. Laboratory				
	8. Out Patient Departments				
	9. Wards				
	10. Operation Theatre				
	11. Emergency Department				
	12. Administration				

5 Hospital Performance Evaluation and Recommendations

5.1 Performance Evaluation

Building performance is a combination of the performance of both structural and non-structural components. Based upon the structural and non-structural vulnerability assessment of the hospital buildings and different critical systems and facilities, the functional assessment of the hospital shall be made for at least two scenario earthquakes. Table 6 below shows a format for defining the probable functional status of the hospital after earthquake events.

Table 6: Expected Seismic Performance of Assessed Hospitals in Different Earthquake Scenarios

Hospitals	Earthquake Scenario	
	Moderate Earthquake (MMI VI – MMI VII)	Severe Earthquake (MMI VIII – MMI IX)

5.2 Comparison with Standard Risk Acceptance Matrix

The Risk Acceptance Matrix proposed by Structural Association of California (SEAOC), has been used as a standard for this guideline. It is given in **Fig 5** below. Plotting of the estimated seismic performance of the assessed hospitals in the standard risk acceptance matrix gives an overall view of the status of the hospitals in comparison with expected performance. Different building performance levels are explained in **Annex XI**.

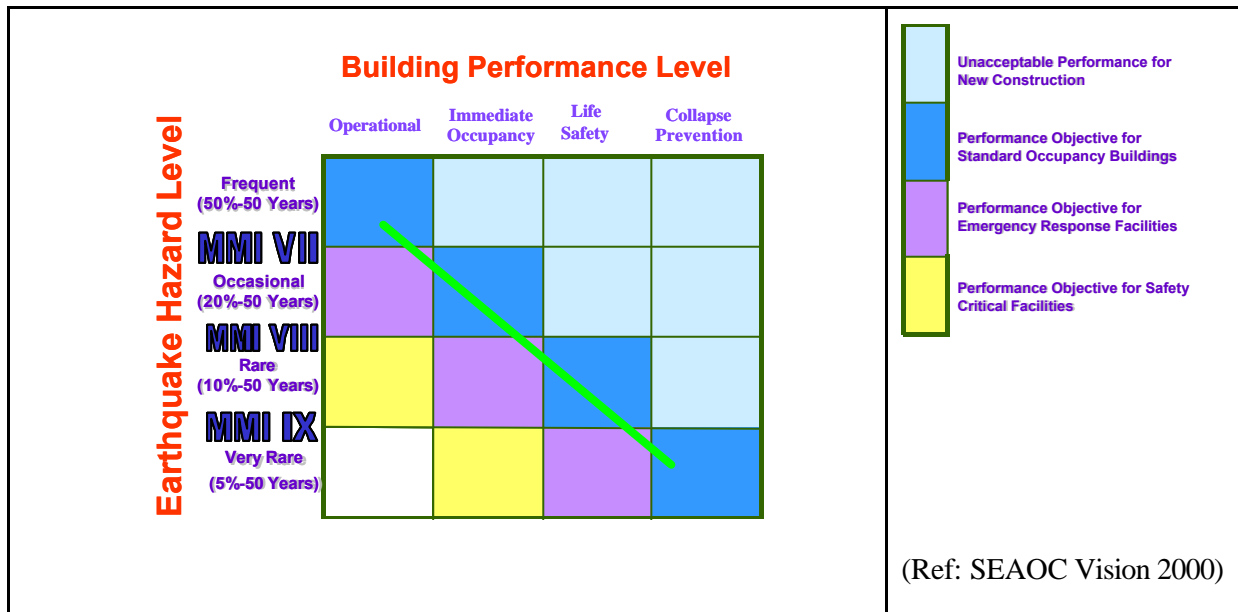

Figure 5: Risk Acceptance Matrix

5.3 Recommendations

Based upon the structural and non-structural assessment of the hospital, priority-wise recommendations should be made for improving the seismic performance of the hospital. The seismic vulnerability of different systems, technical and economical feasibility of implementing mitigation options, structural vulnerability and importance of the different critical systems and departments for operating the hospital after an earthquake shall be taken as basis for the prioritization. In addition, the priority should follow some logical sequence of improving the functional status of the hospital after an earthquake. It is recommended to

discuss with hospital administration at the time of drawing recommendations. It is suggested to prepare phase-wise lists of prioritized actions and the cost required. **Table 7** gives a format for recommendations.

Table 7: Format for Recommendations

<i>Phase I: Recommended Improvements of the Performance Expected to Render the Hospital Fully Operational after a Moderate Earthquake</i>			
Recommendations	Priority	Estimated Cost (US\$)	Remarks
1. Fixing of all equipment and contents.	First		
2. Provision of extra fuel for the generator.	First		
3.			
4.			
Total cost for Implementing Phase-I recommendations			
<i>Phase II: Additional Recommendations for Improving the Performance of the Hospital to a Desirable Level after a Severe Earthquake</i>			
Recommendations	Priority	Estimated Cost (US\$)	Remarks
5. Installation of a deep boring system for water with a 50,000 liters overhead tank and treatment plant.	Second		
6. Retrofitting of Block#1.	Third		
7. Reconstruction of Block#2.	Third		
8.			
9.			
Total cost for Implementing Phase-II recommendations			

5.4 Expected Performance of the Hospital after Implementation of Recommendations

The expected performance of the hospital after implementation of Phase I & II of the recommendations shall be compared with the standard risk acceptance matrix mentioned above. The comparison of the cost required and the expected safety level of the hospital after implementing the different phases of recommendations can be helpful when planning mitigation actions.

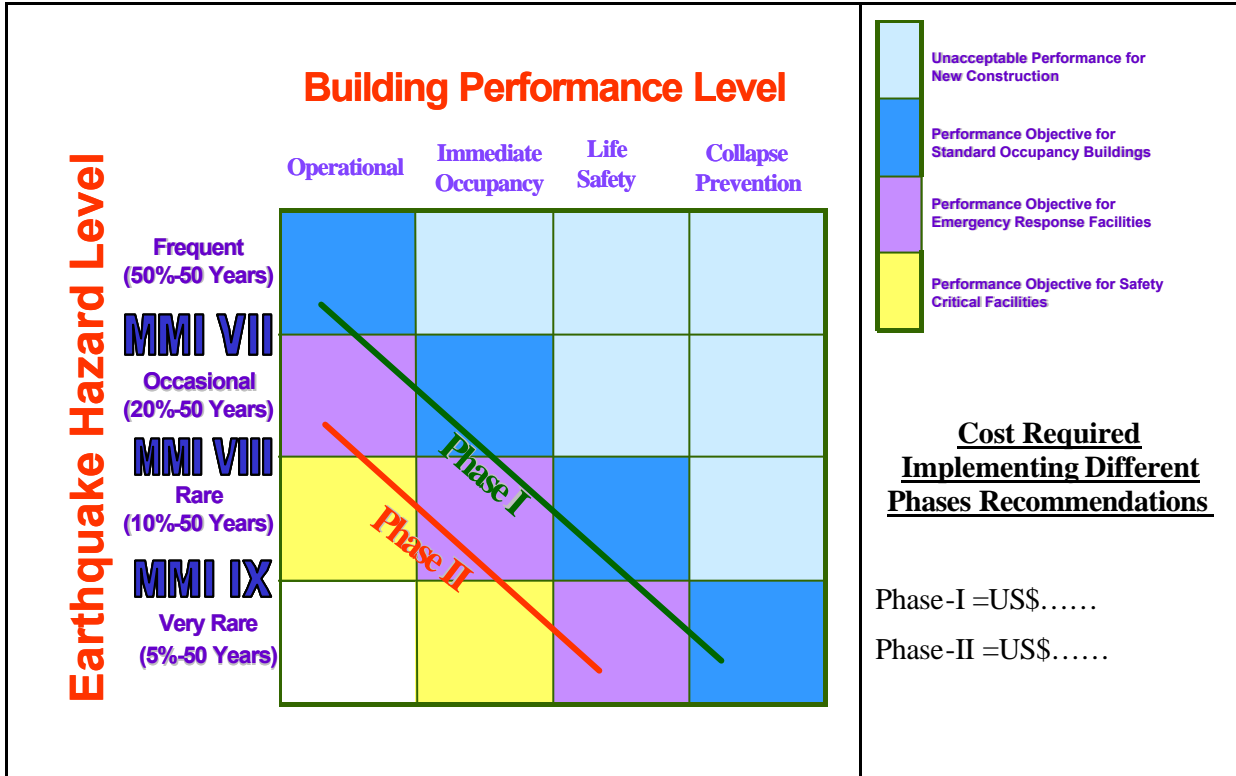

6 References

1. Rana B.S.J.B., “1934 Great Earthquake of Nepal”, 1935 (In Nepali)
2. Nippon Koei Co., LTD. and Oyo Corporation, “*The Study on Earthquake Disaster Mitigation in the Kathmandu Valley Kingdom of Nepal*”, Final Report (2), 2002.
3. Patton R, Thomas B, Basnet R, Guragain R., “*A Report on Emergency Preparedness and Seismic Vulnerability of Bir Hospital*”, National Society for Earthquake Technology-Nepal (NSET), 2000.
4. World Health Organization Nepal (WHO), “*A Structural Vulnerability Assessment of Hospitals in Nepal*”, 2002.
5. National Society for Earthquake Technology-Nepal (NSET), “*Non-Structural Vulnerability Assessment of Hospitals in Nepal*”, 2003.
6. Ministry of Health / Department of Health Services / Epidemiology & Disease Control Division, “*Health Sector Emergency Preparedness & Disaster Response Plan Nepal*”, 2003.
7. Johnson GS, Sheppard RE, Quilici MD, Eder SJ, Scawthorn CR., “*Seismic Reliability Assessment of Critical Facilities: A Handbook, Supporting Documentation and Modal Code Provisions*”, Technical report MCEER-99-0008, 1999.
8. World Health Organization (WHO), “*Protocol for Assessment of the Health Facilities in Responding to Emergencies*”, 1999.
9. New Zealand Standard (NZS), “*Seismic Restraint of Building Contents*”, NZS 4104:1994.
10. New Zealand Standard (NZS), “*Specification for Seismic Resistance of Engineering Systems in Buildings*”, NZS 4219:1983.
11. Federal Emergency Management Agency (FEMA), “*NEHRP Guidelines for the Seismic Rehabilitation of Buildings*”, FEMA-273, 1997.
12. Federal Emergency Management Agency (FEMA), “*Handbook for Seismic Evaluation of Buildings-A Prestandard*”, FEMA-310, 1998.
13. Building Code Development Project (BCDP), “*The Development of Alternative Building Materials and Technologies for Nepal*”, Appendix C: “*Seismic Vulnerability Analysis*”, 1994.
14. Structural Engineers Association of California (SEAOC), “*Vision 2000-A Framework for Performance Based Design*”, 1995.
15. Federal Emergency Management Agency (FEMA), “*Prestandard and Commentary for the Seismic Rehabilitation of Buildings*”, FEMA-356, 2000.

GUIDELINES

for Seismic Vulnerability Assessment of

HOSPITALS

Annex I: Checklist for Visiting Hospitals

A I.1	Explain the scope of work and methodology to the hospital administration.....	23
A I.2	Collect information.....	23
A I.3	Visiting essential and critical medical facilities (after collecting information)	24
A I.4	Visiting lifeline critical facilities (after collecting information).....	24
A I.5	Correlation between structural systems, medical facilities and lifeline systems....	24

Annex I: Checklist for visiting Hospitals

A I.1 Explain the scope of work and methodology to the hospital administration

- Explain that the assessment will recommend actions to reduce earthquake vulnerability.
- Explain that the hospital may be visited several times
- Ask for suitable contact persons whom you will be able to contact in future. Usually it will be the people in charge of emergency management and lifeline systems' maintenance and operation.
- Ask for phone numbers and working hours.
- Explain that a draft report will be submitted to the hospital containing the findings from the assessment for review.
- Explain that the final report will be submitted to the hospital.

A I.2 Collect information

- Collect architectural, structural and lifeline systems drawings.
- Collect geotechnical information - boring logs.
- Collect material testing reports made during construction time.
- Ask for damages during previous earthquakes.
- Ask whether there has been any foundation settlements in the past.
- Ask for someone who was present during hospital construction to provide information regarding foundation type, water table level, and structural construction system.
- Ask for building age and how the different facilities were built and added to over time. It is meaningful to get information regarding any new construction work carried out informally, without engineering design, such as adding a new floor.
- Ask the person in charge of lifelines maintenance and operation about any problems that happen during normal and peak operation hours either usually, often or sometimes. In addition, enquire about needs and thoughts about how to reduce non-structural vulnerability.
- Ask the person in charge of lifelines maintenance and operation about maintenance demands; whether it is increasing with time, how water and energy supply is improving or getting worse with time. Also include aspects such as waste water disposal, toxic releases (e.g. gasses, chemicals) and so on.
- Ask about the maintenance routine.
- Ask the person in charge of emergency services about any problems that happen during normal and peak operation hours either usually, often or sometimes. In addition, enquire about needs and thoughts about how to reduce these problems.
- Ask the person in charge of emergency services about emergency demands; whether it is increasing with time and what the most common cases for treatment are.
- Ask about the feasibility of conducting new geotechnical studies such as boring holes and open mining for inspecting foundations and destructive material testing in beams and walls.
- Ask the hospital director to confirm the number of beds, doctors and nurses as well as the bed occupancy rate, number of daily surgeries, number of patients utilizing emergency services, number of patients in consultancy and any other statistics considered relevant for understanding the hospital capacity and what percentage of its

capacity is being used under normal circumstances.

A 1.3 Visiting essential and critical medical facilities (after collecting information)

- Operation Theatres, Intensive Care Unit, Burns Unit, Central Sterile Services Department (CSSD), Neuro-Surgical Unit, Emergency Department, Labs, Radiology, Nuclear Medicine, Blood Bank, and any other essential and critical facilities need to be inspected.
- Inspect any facility that operates hazardous materials that can flame or cause problems as a collateral risk triggered by an earthquake.
- Inspect any facility that operates sub-structures such as tanks for haemodialysis etc.

A 1.4 Visiting lifeline critical facilities (after collecting information)

- Inspect the energy feeders and distribution through the building (capacity, redundancy and dependency) as well as emergency generators for backup energy (time, redundancy, % of demand covered, served areas etc.). Ask about the peak hour demand.
- Inspect and ask about the water supply system (capacity, redundancy, and dependency). Ask about the peak hour demand. Enquire about water treatment plants, storage tanks placed on the roof that may cause eccentric masses and torsion on the building.
- Inspect the sewerage system. Ask about areas affected by wastewater, toxic, hazardous material and garbage disposal. Ask about and search for leakages of any fluid that can cause damage to RC or structural materials such as deterioration of concrete strength, steel bar corrosion, and so on.
- Inspect the steam system if it provides energy to autoclaves and sterilization units connected with critical facilities. Inspect the central boiler house, especially if it is inside the main building as there might be soft story there or problems with lifelines passing through seismic joints.
- Gas systems such as oxygen, air-suction, and nitrous oxide should be inspected. Ask for the pipeline layout. In general, these kinds of facilities usually consist of fragile pipes and it is therefore necessary to assess whether or not they are crossing through seismic joints in a proper way.
- Check storage and usage of liquefied petroleum gas cylinders as well as any other means of fuel used in the hospital to provide energy to kitchen, laundry, etc.
- Inspect communication systems such as telephones, radio calls, alarms, pagers, local intercoms and others. Assess their reliability in case of emergency.
- Inspect transportation facilities such as lifts as well as corridors, gates, stairs, etc. Assess their reliability and means of egress in case of an emergency.

A 1.5 Correlation between structural systems, medical facilities and lifeline systems.

- Inspect all seismic joints to observe if they work properly or not. In addition, try to identify any lifeline going through a seismic joint, the use of flexible connectors etc.
- Inspect all areas of possible structural intervention in future such as facades, corners, seismic joints, columns etc.
- Beware and search for lifelines attached to structural elements.
- Identify the everyday usage of any possible area of future intervention. Try to avoid areas where essential and critical facilities are located. If it is not possible to avoid an intervention in a place where these facilities are placed, try to find a solution to keep medical services working.

GUIDELINES

for Seismic Vulnerability Assessment of

HOSPITALS

Annex II: Hospital Buildings Typology

A II.1	Type 1 - Adobe, stone in mud, brick-in-mud (low strength masonry).....	27
A II.2	Type 2 - Brick in cement, stone in cement.....	27
A II.3	Type 3 - Reinforced concrete ordinary-moment-resistant-frames (OMRF).	28
A II.4	Type 4 - Reinforced concrete intermediate-moment-resistant-frames (IMRF).....	29
A II.5	Type 5 - Reinforced concrete special-moment-resistant-frames (SMRF).	29
A II.6	Type 6 - Other	29

Annex II: Hospital Buildings Typology

A II.1 Type 1 - Adobe, stone in mud, brick-in-mud (low strength masonry).

These buildings are mud-based constructed buildings and rarely used by hospitals nowadays. However, some parts of hospital facilities may still be in such buildings in rural areas. The vulnerability of these types of buildings mainly depends on the inherent structural strength of the wall material together with the technology of construction. Vertical wooden posts and horizontal wooden elements embedded in walls are the expected key earthquake resistant elements in these buildings. The type of floor and roof used such as flat or sloping, heavy or light, properly fixed with walls or simply rested, braced or un-braced etc. highly influence the vulnerability of such buildings.

Adobe Buildings: These are buildings constructed using sun-dried bricks (earthen) with mud mortar for the construction of the structural walls. The walls are usually more than 350 mm. thick. The use of such type of buildings as a hospital is not very frequent.

Stone in Mud: These are stone-masonry buildings constructed using dressed or undressed stones with mud mortar. They generally have flexible floors and roofs. Some buildings used as district hospitals in hilly areas might be of this type.

Brick in Mud: These are brick masonry buildings with fired bricks in mud mortar. Some old buildings used by hospitals might be of this type.

A II.2 Type 2 - Brick in cement, stone in cement

These types of buildings are the most common hospital buildings in Nepal whether inside or outside Kathmandu Valley. Hospital Buildings that are more than 15-20 years old are mostly this type.



Photo II-1: Brick in cement building



Photo II-2: Stone in cement building

Main features of this type of buildings are as follows:

- Foundations are usually openly-excavated strip footings built of stone in mud mortar or brickwork in cement mortar up to the ground-level. The plinth masonry above ground-level to the plinth-level is brickwork in cement mortar, the thickness of walls being about half a brick larger than the superstructure walls.
- The superstructure walls are one brick thick constructed in 1:6 cement sand mortar, in general. Bricks are of a good quality, usually with a crushing strength of more than 7.5 N/mm². The construction quality is good with soaking of bricks beforehand and filling of joints with mortar.
- The number of stories usually goes up to three. The floors are of either reinforced concrete or reinforced brick slabs. The roof is also of similar construction although in some cases it is made sloping using RC slabs.

- The use of lintel-level bands is not practiced. Rarely, a peripheral beam is cast with the floor slab.

A II.3 Type 3 - Reinforced concrete ordinary-moment-resistant-frames (OMRF).

This is a new type of building construction that consists of a frame assembly of cast-in-place concrete beams and columns. The floors and roof consist of cast-in-place concrete slabs. Walls consist of infill panels constructed of solid clay bricks. The present trend of building construction in urban areas of Nepal for residential, shop-cum-residential and shop-cum-office-cum-residential buildings is to use reinforced concrete beam-column frames with randomly-placed brick walls in two directions. In many cases, newly constructed hospital buildings are also of this type. Some of the conspicuous features of such buildings are:

- *Planning:* The column spacing in each direction of the building varies from 3 m to 4.5 m. In most cases, the storey-heights are 2.7 m but sometimes they are up to 3.0 m floor-to-floor. Internal partitions and parapet walls are usually half-a-brick thick while external walls are one-brick thick with relatively big openings for windows.
- *Foundations:* Individual column footings type foundation. The area generally varies from 1.2 m x 1.2 m to 2.0m x 2.0m. The depth varies from 0.9 to 1.2 m below ground level.
- *Columns:* A 230 x 230 mm (9" x 9") column-size is the most common and is used, even for up to five stories, both for face and internal columns. The longitudinal reinforcement commonly used is 4 bars of 16 f and 2 bars of 12f of high-strength steel (Fe415) and the ties are usually either 6 f plain mild steel (Fe250) or 5 f high-strength twisted steel (Fe550) at 200 mm centers.
- *Beams:* A usual size is 230 x 230 mm (9" x 9"), with a web projecting below a slab with which it is monolithic, with three to four 12 f bars of high-strength bottom steel and two similar bars at the top. Out of the bottom bars, one or two bars are cranked up, making three to four bars near the supports for the hogging moment.
- *Slabs:* The slabs are usually made of reinforced concrete or reinforced brick concrete (RBC) 75 to 100 mm (3" to 4") thick, with 10 f high-strength steel at 130 mm centers spanning the shorter dimension and the same at 250 centers in the longer span. Alternate bars are bent up near supports to carry the negative moment.



Photo II-3: Ordinary Moment Resisting Frame Building

The seismic performance of this type of construction depends on the interaction between the frame and the infill panels. The combined behavior is more like a shear wall structure than a frame structure. Solidly in-filled masonry panels form diagonal compression struts between the intersections of the frame members. If the walls are offset from the frame and do not fully engage the frame members, the diagonal compression struts will not develop. The strength of

the infill panel is limited by the shear capacity of the masonry bed joint or the compression capacity of the strut. The post-cracking strength is determined by an analysis of a moment frame that is partially restrained by the cracked infill. The shear strength of the concrete columns, after cracking of the infill, may limit the semi ductile behavior of the system.

The buildings can further be divided into two sub groups, considering the number of stories, as the vulnerability of these types of buildings highly depends on the number of stories.

A: ORMF with more than three stories.

B: ORMF less or equal to three stories.

A II.4 Type 4 - Reinforced concrete intermediate-moment-resistant-frames (IMRF).

These buildings consist of a frame assembly of cast-in-place concrete beams and columns. Floor and roof framing consists of cast-in-place concrete slabs. Lateral forces are resisted by concrete moment frames that develop their stiffness through monolithic beam-column connections. These are buildings designed with old codes or designed for small earthquake forces. Some of the newly constructed reinforced concrete hospital buildings are likely to be of this type.

A II.5 Type 5 - Reinforced concrete special-moment-resistant-frames (SMRF).

These buildings consist of a frame assembly of cast-in-place concrete beams and columns. Floor and roof framing consists of cast-in-place concrete slabs. Lateral forces are resisted by concrete moment frames that develop their stiffness through monolithic beam-column connections. These buildings have joint reinforcing, closely spaced ties, and special detailing to provide ductile performance. Despite the fact that this system should be adopted for all new RC frame hospital buildings in Nepal, it is now only used as an exception.

A II.6 Type 6 - Other

If the hospital building does not fall within one of the categories mentioned above. The building may have different seismic behavior depending on its inherent strengths and weaknesses.

GUIDELINES

for Seismic Vulnerability Assessment of



HOSPITALS



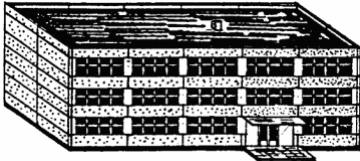

Annex III: Probable Damage Grade of Different Building Typology

A III.1	Damage Grades	33
A III.2	Probable Damage Grade of Different Buildings Typology.....	35
<i>A III.2.1</i>	<i>Building Type 1: Adobe, Stone in Mud and Brick in Mud.....</i>	<i>35</i>
<i>A III.2.2</i>	<i>Building Type 2: Brick in Cement, Stone in Cement and well built Brick in Mud.....</i>	<i>35</i>
<i>A III.2.3</i>	<i>Building Type 3A: Reinforced Concrete Ordinary Moment Resisting Frame (=3 Storied).....</i>	<i>35</i>
<i>A III.2.4</i>	<i>Building Type 3B: Reinforced Concrete Ordinary Moment Resisting Frame (>3 Storied).....</i>	<i>35</i>
<i>A III.2.5</i>	<i>Building Type 4: Reinforced Concrete Intermediate-Moment-Resisting-Frame (IMRF)</i>	<i>36</i>
<i>A III.2.6</i>	<i>Building Type 5: Reinforced Concrete Special-Moment-Resisting-Frame (SMRF).....</i>	<i>36</i>

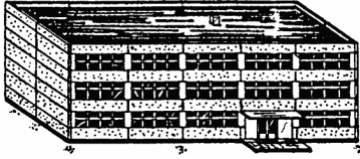
Annex III: Probable Damage Grade of Different Building Typology

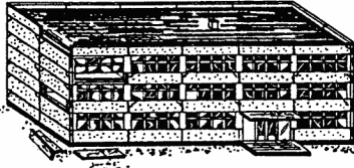
A III.1 Damage Grades

Illustration of Damage on Buildings		Damage Grade as per EMS 98	Damage Grade as per Nepal National Building Code
Masonry	Reinforced Concrete		
		<p>Grade 1 (DG1): Negligible to Slight Damage (No structural damage, slight non-structural damage)</p> <p><u>Masonry Buildings</u></p> <ul style="list-style-type: none"> • Hair-line cracks in very few walls • Fall of small pieces of plaster only • Fall of loose stones from upper parts of buildings in very few cases. <p><u>Reinforced Concrete Buildings</u></p> <ul style="list-style-type: none"> • Fine cracks in plaster over frame members or in walls at base • Fine cracks in partitions and infills 	<p>Grade 1: Slight Damage</p> <ul style="list-style-type: none"> • Fine cracks in plaster • Fall of small pieces of plaster
		<p>Grade 2 (DG2): Moderate Damage (Slight structural damage, moderate non-structural damage)</p> <p><u>Masonry Buildings</u></p> <ul style="list-style-type: none"> • Cracks in many walls • Fall of fairly large pieces of plaster • Partial collapse of chimneys <p><u>Reinforced Concrete Buildings</u></p> <ul style="list-style-type: none"> • Cracks in columns and beams of frames and in structural walls • Cracks in partition and infill walls; fall of brittle cladding and plaster • Falling mortar from the joints of wall panels 	<p>Grade 2: Moderate Damage</p> <ul style="list-style-type: none"> • Small cracks in walls • Fall of fairly large pieces of plaster • Pan tiles slip off • Cracks in chimneys • Parts of chimney falls down

		<p>Grade 3 (DG3): Substantial to Heavy Damage (Moderate structural damage, heavy non-structural damage)</p> <p><u>Masonry Buildings</u></p> <ul style="list-style-type: none"> • Large and extensive cracks in most walls • Roof tiles detach; chimneys fracture at the roof line; failure of individual non-structural elements (partitions, gable walls) <p><u>Reinforced Concrete Buildings</u></p> <ul style="list-style-type: none"> • Cracks in columns and beam column joints of frames at the base and at joints of coupled walls • Spalling of concrete cover, buckling of reinforced rods • Large cracks in partition and infill walls, failure of individual infill panels 	<p>Grade 3: Heavy Damage</p> <ul style="list-style-type: none"> • Large and deep cracks in walls • Fall of chimneys
		<p>Grade 4 (DG4): Very Heavy Damage (Heavy structural damage, very heavy non-structural damage)</p> <p><u>Masonry Buildings</u></p> <ul style="list-style-type: none"> • Serious failure of walls; partial structural failure of roofs and floors <p><u>Reinforced Concrete Buildings</u></p> <ul style="list-style-type: none"> • Large cracks in structural elements with compression failure of concrete fracture of rebar; bond failures of beam reinforced bars; tilting of columns. • Collapse of a few columns or of a single upper floor 	<p>Grade 4: Destruction</p> <ul style="list-style-type: none"> • Gaps in wall • Parts of buildings may collapse • Separate parts of the building loose their cohesion • Inner walls collapse
		<p>Grade 5 (DG5): Destruction (Very heavy structural damage)</p> <p><u>Masonry Buildings</u></p> <ul style="list-style-type: none"> • Total or near total collapse <p><u>Reinforced concrete Buildings</u></p> <p>Total or near total collapse</p>	<p>Grade 5: Total Damage</p> <ul style="list-style-type: none"> • Total collapse of building

A III.2 Probable Damage Grade of Different Buildings Typology

A III.2.1 Building Type 1: Adobe, Stone in Mud and Brick in Mud

MMI		VI	VII	VIII	IX	X
Damage Grades for Different Classes of Buildings	Weak	DG4	DG5	DG5	DG5	DG5
	Average	DG3	DG4	DG5	DG5	DG5
	Good	DG2	DG3	DG4	DG4	DG5

A III.2.2 Building Type 2: Brick in Cement, Stone in Cement and well built Brick in Mud

MMI		VI	VII	VIII	IX	X
Damage Grades for Different Classes of Buildings	Weak	DG2	DG3	DG4	DG5	DG5
	Average	DG1	DG2	DG3	DG4	DG5
	Good	-	DG1	DG2	DG3	DG4

A III.2.3 Building Type 3A: Reinforced Concrete Ordinary Moment Resisting Frame (= 3 Storied)

MMI		VI	VII	VIII	IX	X
Damage Grades for Different Classes of Buildings	Weak	DG1	DG2	DG3	DG4	DG5
	Average	-	DG1	DG2	DG3	DG4
	Good	-	-	DG1	DG2	DG3

A III.2.4 Building Type 3B: Reinforced Concrete Ordinary Moment Resisting Frame (>3 Storied)

MMI		VI	VII	VIII	IX	X
Damage Grades for Different Classes of Buildings	Weak	DG1	DG2	DG3-DG4	DG5	DG5
	Average	-	DG1	DG2-DG3	DG4	DG5
	Good	-	DG1	DG2	DG3	DG4

A III.2.5 Building Type 4: Reinforced Concrete Intermediate-Moment-Resisting-Frame (IMRF)

MMI		VI	VII	VIII	IX	X
Damage Grades for Different Classes of Buildings	Weak	-	DG1	DG2	DG3	DG4
	Average	-	-	DG1	DG2	DG3
	Good	-	-	-	DG1	DG2

A III.2.6 Building Type 5: Reinforced Concrete Special-Moment-Resisting-Frame (SMRF)

MMI		VI	VII	VIII	IX	X
Damage Grades for Different Classes of Buildings	Weak	-	DG1	DG2	DG3	DG4
	Average	-	-	-	DG1	DG2
	Good	-	-	-	-	DG1

GUIDELINES

for Seismic Vulnerability Assessment of

HOSPITALS

Annex IV: Seismic Vulnerability Factors

A IV.1	Basic Factors Influencing the Seismic Performance of Buildings	39
A IV.2	Configuration	41
A IV.3	Factors Associated with Lateral Force Resisting System of Different Buildings Influencing the Seismic Performance	45
A IV.4	Unreinforced Masonry Shear Walls.....	48
A IV.5	Infill Walls in Frames	48
A IV.6	Factors Associated with Diaphragms	49

List of Figures

Figure A IV-1: Load path problem.....	39
Figure A IV-2: Different floor height buildings suffer more in pounding.....	40
Figure A IV-3: Pounding due to small gap between two buildings	40
Figure A IV-4: Sufficient gap between two buildings prevents pounding.....	40
Figure A IV-5: Soft storey due to excessive floor height in the ground storey	41
Figure A IV-6: Soft storey due to lack of brick infill	42
Figure A IV-7: Vertical irregularity in buildings	42
Figure A IV-8: Shear walls in cantilever.....	43
Figure A IV-9: Excessive setback	43
Figure A IV-10: Mass irregularity	43

Annex IV: Seismic Vulnerability Factors

A IV.1 Basic Factors Influencing the Seismic Performance of Buildings

A IV.1.1 Load Path

The general load path of a building is as follows: seismic forces originating throughout the building are delivered through structural connections to horizontal diaphragms; the diaphragms distribute these forces to vertical lateral-force-resisting elements such as shear walls and frames; the vertical elements transfer the forces into the foundation; and the foundation transfers the forces into the supporting soil.

There must be a complete lateral-force-resisting system that forms a continuous load path between the foundation, all diaphragm levels, and all portions of the building for proper seismic performance. If there is a discontinuity in the load path, the building is unable to resist seismic forces regardless of the strength of the existing elements. Mitigation with elements or connections needed to complete the load path is necessary to achieve the selected performance level.

Examples would include a masonry shear wall that does not extend to the foundation, or a column in an upper story that does not continue to the foundation.

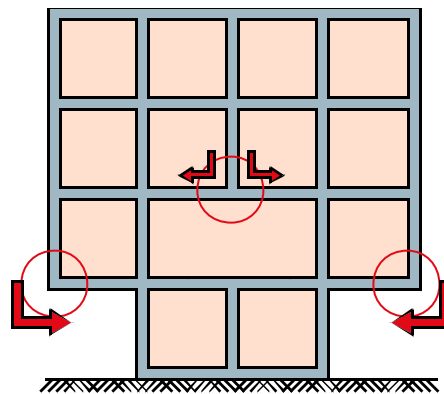

Figure A IV-1: Load path problem

Is there any masonry wall in cantilever?

Any column has started from beam? Not continued from the foundation?

Is there any masonry wall, which does not continue to the foundation?

If yes, there is problem of clear load path!

A IV.1.2 Adjacent Buildings and POUNDINGS

If buildings are built without sufficient gaps between them and the interaction has not been considered, the buildings may impact with each other, or pound, during an earthquake. Building pounding can alter the dynamic response of both buildings and impart additional inertial loads on both structures. Buildings of the same height with matching floors will exhibit similar dynamic behavior. If the buildings pound, floors will impact with other floors, which means that damage due to pounding usually will be limited to nonstructural components. However, when the floors of adjacent buildings are at different elevations, floors will impact with the columns of the adjacent building and that can cause structural damage. Since neither building is designed for these conditions, there is a potential for extensive damage and possible collapse.

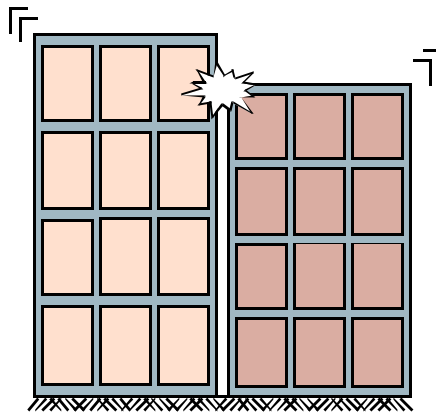

Figure A IV-2: *Different floor height buildings suffer more in pounding*

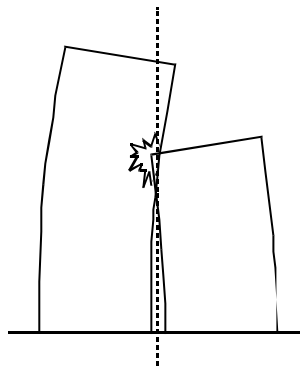

Figure A IV-3: *Pounding due to small gap between two buildings*

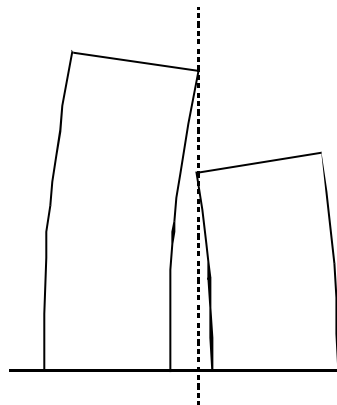

Figure A IV-4: *Sufficient gap between two buildings prevents pounding*

Is the building attached to another building and there is no gap between them?
 Is there a gap between them but the gap is filled with rigid material like concrete or brick?
 Is the gap made rigid with the use of metal or any other rigid material at the floor levels?
 If yes, there might be a problem of pounding. When the floor levels of the adjacent buildings are at different levels, there will be increased effects of the pounding.

A IV.2 Configuration

Configuration of buildings is related to dimensions, building form, geometric proportions and the location of structural components. The configuration of a building will influence its seismic performance, particularly regarding the distribution of the seismic loads.

Based on past earthquake experiences, it can be stated that symmetrical buildings with simple configurations are more resistant to earthquake shaking. Good details and construction quality are of secondary value if a building has an odd shape that is not properly considered in the design. Although a building with an irregular configuration may be designed to meet all code requirements, irregular buildings generally do not perform as well as regularly shaped buildings in an earthquake. Typical building configuration deficiencies include an irregular geometry, a weakness in a given story, a concentration of mass, or a discontinuity in the lateral force resisting system.

Vertical irregularities are defined in terms of strength, stiffness, geometry, and mass. These factors are evaluated separately but are related and may occur simultaneously. Horizontal irregularities involve the horizontal distribution of lateral forces to the resisting frames or shear walls.

A IV.2.1 Weak Story

The story strength is the total strength of all the lateral force-resisting elements in a given story for the direction under consideration. It is the shear capacity of columns or shear walls. If the columns are flexural controlled, the shear strength is the shear corresponding to the flexural strength. Weak stories are usually found where vertical discontinuities exist, or where member size or reinforcement has been reduced. It is necessary to calculate the story strengths and compare them. The result of a weak story is a concentration of inelastic activity that may result in the partial or total collapse of the story.

A IV.2.2 Soft Story

This condition commonly occurs in hospital buildings with particularly tall first stories. Such cases are not *necessarily* soft stories because the tall columns may have been designed with appropriate stiffness, but they are *likely* to be soft stories if they have been designed without consideration for inter-story drift. Soft stories are usually revealed by an abrupt change in inter-story drift. Although a comparison of the stiffness in adjacent stories is the direct approach, a simple first step might be to plot and compare the inter-story drifts if analysis results happen to be available.

The difference between "soft" and "weak" stories is the difference between stiffness and strength. A column may be limber but strong or stiff but weak. A change in column size can affect strength and stiffness and both need to be considered.

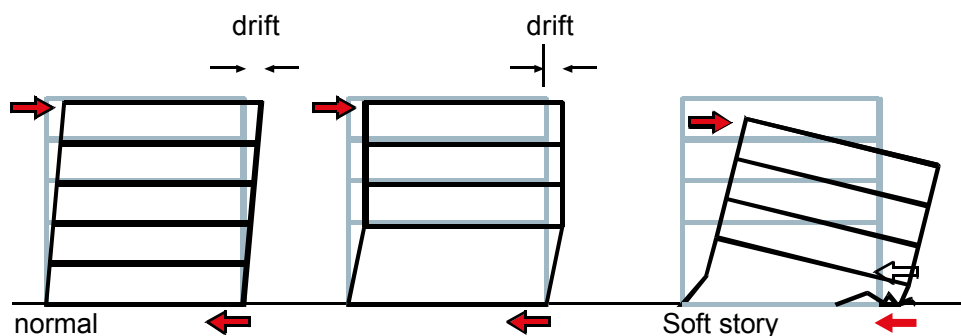

Figure A IV-5: Soft storey due to excessive floor height in the ground storey

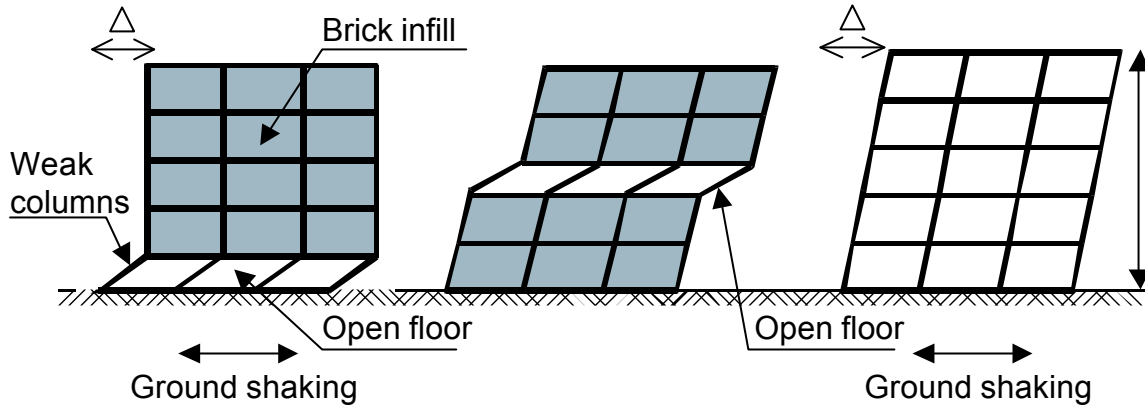

Figure A IV-6: Soft storey due to lack of brick infill

Is there vertical discontinuity of shear walls or columns in the ground or any other story?
Is there any open story?
Is the column or floor height of any one story more than that of adjacent story?
If yes, there may be problems of weak or soft stories.

A IV.2.3 Geometry

Geometric irregularities are usually detected through an examination of the story-to-story variation in the dimensions of the lateral-force-resisting system. A building with upper stories set back from a broader base structure is a common example. Another example is a story in a high-rise that is set back for architectural reasons. It should be noted that the irregularity of concern is in the dimensions of the lateral-force-resisting system and not the dimensions of the envelope of the building, and, as such, it may not be obvious.

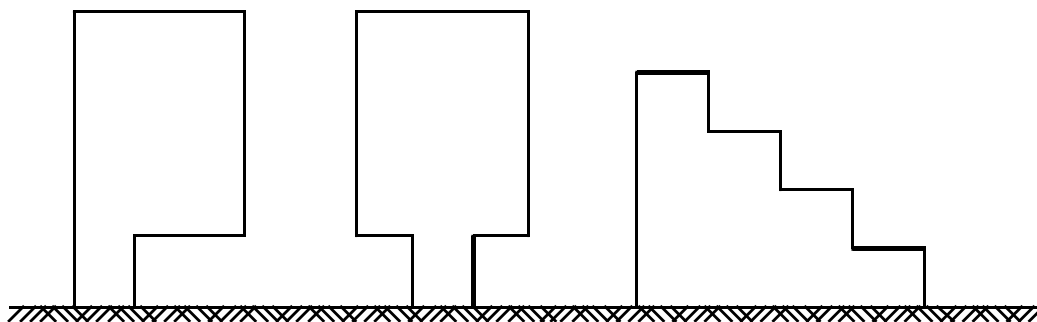

Figure A IV-7: Vertical irregularity in buildings

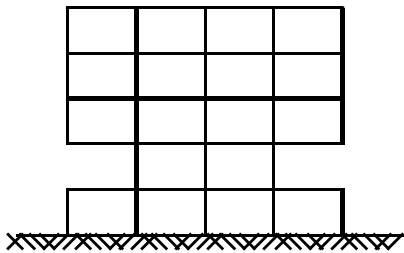

Figure A IV-8: Shear walls in cantilever

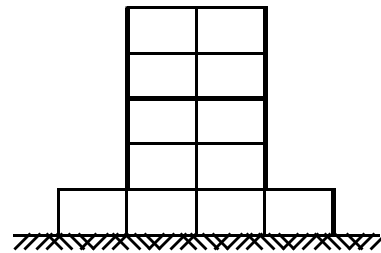

Figure A IV-9: Excessive setback

Are the shear walls or the columns of a story setback as compared to the adjacent story?

Are the shear walls or the columns of a story placed in projected parts as compared to the adjacent stories?

If yes, there is problem in geometry.

A IV.2.4 Vertical Discontinuities

Vertical discontinuities are usually detected by visual observation. The most common example is a discontinuous column or masonry shear wall. The element is not continuous to the foundation but stops at an upper level. The shear at this level is transferred through the diaphragm to other resisting elements below.

This issue is a local strength and ductility problem below the discontinuous element, not a global story strength or stiffness irregularity. The concern is that the wall or frame may have more shear capacity than considered in the design.

Is there any column or shear wall that is not continuing to the foundation? If so, that is vertical discontinuities. (**Fig A IV-1**)

A IV.2.5 Mass

Mass irregularities can be detected by comparison of the story weights. The effective mass consists of the dead load of the structure on each level plus the actual weight of partitions and permanent equipment on each floor. The validity of this approximation is dependent upon the vertical distribution of mass and stiffness in the building.

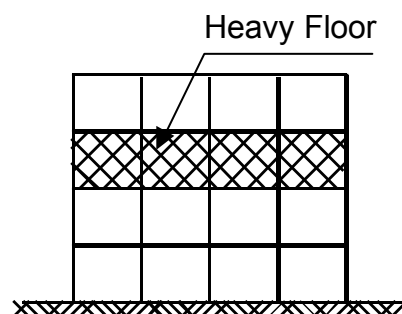

Figure A IV-10: Mass irregularity

Are there heavy walls as compared to the adjacent stories?

Is there heavy equipment as compared to that in the adjacent stories?

Is the thickness of the floor diaphragm more than that of the adjacent floor?

Is the mass due to all structural and non-structural components in story is less or more than 50% of that of the adjacent stories?

If yes, there may be mass irregularities.

A IV.2.6 Torsion

Whenever there is significant torsion in a building, the concern is for additional seismic demands and lateral drifts imposed on the vertical elements by rotation of the diaphragm. Buildings can be designed to meet code forces including torsion, but buildings with severe torsion are less likely to perform well in earthquakes. It is best to provide a balanced system at the start rather than design torsion into the system.

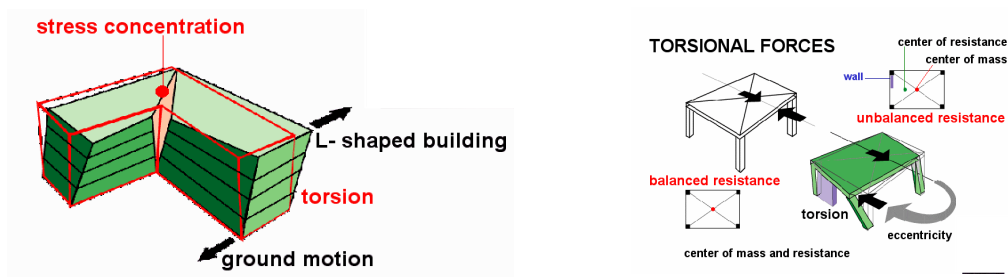

A IV.2.7 Condition of Materials

Deteriorated structural materials may reduce the capacity of the vertical- and lateral-force-resisting systems. The most common type of deterioration is caused by the intrusion of water. Stains may be a clue to water-caused deterioration where the structure is visible on the exterior, but the deterioration may be hidden where the structure is concealed by finishes. In the latter case, the assessment team may have to find a way into attics, plenums, and crawl spaces in order to assess the structural systems and their condition.

A IV.2.8 Deterioration of Wood

The condition of the wood in a structure has a direct relationship as to its performance in a seismic event. Wood that is split, rotten, or has insect damage may have a very low capacity to resist loads imposed by earthquakes. Structures with wood elements depend to a large extent on the connections between members. If the wood at a bolted connection is split, the connection will possess only a fraction of the capacity of a similar connection in undamaged wood.

A IV.2.9 Deterioration of Concrete

Deteriorated concrete and reinforcing steel can significantly reduce the strength of concrete elements. This statement is concerned with deterioration such as spalled concrete associated with rebar corrosion and water intrusion. Cracks in concrete are another problem. Spalled concrete over reinforcing bars reduces the available surface for bonding between the concrete

and the steel. Bar corrosion may significantly reduce the cross section of the bar.

Deterioration is a concern when the concrete cover has begun to spall, and there is evidence of rusting at critical locations.

A IV.2.10 Masonry Units and Joints

Deteriorated or poor quality masonry elements can result in significant reductions in the strength of structural elements. Older buildings constructed with lime mortar may have surface re-pointing but still have deteriorated mortar in the main part of the joint. Mortar that is severely eroded or can easily be scraped away has been found to have low shear strength, which results in low wall strength.

A IV.2.11 Un-reinforced Masonry Wall Cracks

Diagonal wall cracks, especially along the masonry joints, may affect the interaction of the masonry units leading to a reduction of strength and stiffness. The cracks may indicate distress in the wall from past seismic events, foundation settlement, or other causes.

Crack width is commonly used as a convenient indicator of damage to a wall, but it should be noted that other factors, such as location, orientation, number, distribution and pattern of the cracks could be equally important in measuring the extent of damage present in the shear walls. All these factors should be considered when evaluating the reduced capacity of a cracked element.

A IV.2.12 Cracks in Boundary Columns

Small cracks in concrete elements have little effect on the strength. A significant reduction in strength is usually the result of large displacements or crushing of concrete. Only when the cracks are large enough to prevent aggregate interlock or have the potential for buckling of the reinforcing steel does the adequacy of the concrete element capacity become a concern.

Columns are required to resist diagonal compression strut forces that develop in infill wall panels. Vertical components induce axial forces in the columns. The eccentricity between horizontal components and the beams is resisted by the columns. Extensive cracking in the columns may indicate locations of possible weakness. Such columns may not be able to function in conjunction with the infill panel as expected.

A IV.3 Factors Associated with Lateral Force Resisting System of Different Buildings Influencing the Seismic Performance

A IV.3.1 Moment Frames

Moment frames develop their resistance to lateral forces through the flexural strength and continuity of beam and column elements. In an earthquake, a frame with suitable proportions and details can develop plastic hinges that will absorb energy and allow the frame to survive actual displacements that are larger than calculated in an elastic-based design.

In modern moment frames, the ends of beams and columns, being the locations of maximum seismic moment, are designed to sustain inelastic behavior associated with plastic hinging over many cycles and load reversals. Frames that are designed and detailed for this ductile behavior are called "special" moment frames.

Frames without special seismic detailing depend on the reserve strength inherent in the design of the members. The basis of this reserve strength is the load factors in strength design or the factors of safety in working-stress design. Such frames are called "ordinary" moment frames. For ordinary moment frames, failure usually occurs due to a sudden brittle mechanism such as shear failure in concrete members.

A IV.3.2 General (Redundancy)

Redundancy is a fundamental characteristic of lateral force resisting systems with superior seismic performance. Redundancy in the structure will ensure that if an element in the lateral

force resisting system fails for any reason, there is another element present that can provide lateral force resistance. Redundancy also provides multiple locations for potential yielding, distributing inelastic activity throughout the structure and improving ductility and energy dissipation. Typical characteristics of redundancy include multiple lines of resistance to distribute the lateral forces uniformly throughout the structure, and multiple bays in each line of resistance to reduce the shear and axial demands on any one element.

A distinction should be made between redundancy and adequacy. The redundancy mentioned here is intended to mean simply "more than one." That is not to say that for large buildings two elements is adequate, or for small buildings one is not enough.

A IV.3.3 Moment Frames with Infill Walls

Infill walls used for partitions, cladding or shaft walls that enclose stairs and elevators should be isolated from the frames. If not isolated, they will alter the response of the frames and change the behavior of the entire structural system. Lateral drifts of the frame will induce forces on walls that interfere with this movement. Cladding connections must allow for this relative movement. Stiff infill walls confined by the frame will develop compression struts that will impart loads to the frame and cause damage to the walls. This is particularly important around stairs or other means of egress from the building.

A IV.3.4 Interfering Walls

When an infill wall interferes with the moment frame, the wall becomes an unintended part of the lateral-force-resisting system. Typically these walls are not designed and detailed to participate in the lateral-force-resisting system and may be subject to significant damage. Interfering walls should be checked for forces induced by the frame, particularly when damage to these walls can lead to falling hazards near means of egress. The frames should be checked for forces induced by contact with the walls, particularly if the walls are not full height, or do not completely infill the bay.

A IV.3.5 Concrete Moment Frames

Concrete moment frame buildings typically are more flexible than shear wall buildings. This flexibility can result in large inter-story drifts that may lead to extensive non-structural damage. If a concrete column has a capacity in shear that is less than the shear associated with the flexural capacity of the column, brittle column shear failure may occur and result in collapse.

The following are the characteristics of concrete moment frames that have demonstrated acceptable seismic performance:

- Brittle failure is prevented by providing a sufficient number of beam stirrups, column ties, and joint ties to ensure that the shear capacity of all elements exceeds the shear associated with flexural capacity,
- Concrete confinement is provided by beam stirrups and column ties in the form of closed hoops with 135-degree hooks at locations where plastic hinges will occur.
- Overall performance is enhanced by long lap splices that are restricted to favorable locations and protected with additional transverse reinforcement.
- The strong column / weak beam requirement is achieved by suitable proportioning of the members and their longitudinal reinforcing.

Ordinary-moment-resisting-frame buildings usually do not meet the detail requirements for ductile behavior.

A IV.3.6 Shear Stress Check

The shear stress check provides a quick assessment of the overall level of demand on the structure. The concern is the overall strength of the building.

A IV.3.7 Axial Stress Check

Columns that carry a substantial amount of gravity load may have limited additional capacity to resist seismic forces. When axial forces due to seismic overturning moments are added, the columns may crush in a non-ductile manner due to excessive axial compression.

A IV.3.8 Flat Slab Frames

The concern is the transfer of the shear and bending forces between the slab and column, which could result in a punching shear failure and partial collapse. The flexibility of the lateral-force-resisting system will increase as the slab cracks.

A IV.3.9 Short Captive Columns

Short captive columns tend to attract seismic forces because of high stiffness relative to other columns in a story. Significant damage may occur in columns adjacent to ramping slabs in hospitals. Captive column behavior may also occur in buildings with clearstory windows, or in buildings with partial height masonry infill panels.

If not adequately detailed, the columns may suffer a non-ductile shear failure which may result in partial collapse of the structure.

A captive column that can develop the shear capacity to develop the flexural strength over the clear height will have some ductility to prevent sudden non-ductile failure of the vertical support system.

A IV.3.10 No Shear Failures

If the shear capacity of a column is reached before the moment capacity, there is a potential for a sudden non-ductile failure of the column, leading to collapse.

Columns that cannot develop the flexural capacity in shear should be checked for adequacy against calculated shear demands. Note that the shear capacity is affected by the axial loads on the column and should be based on the most critical combination of axial load and shear.

A IV.3.11 Strong Column Weak Beam

When columns are not strong enough to force hinging in the beams, column hinging can lead to story mechanisms and a concentration of inelastic activity at a single level. Excessive story drifts may result in instability of the frame due to $P-\Delta$ effects. Good post-elastic behavior consists of yielding distributed throughout the frame. A story mechanism will limit forces in the levels above, preventing the upper levels from yielding.

The alternative procedure checks for the formation of a story mechanism. The story strength is the sum of the shear capacities of all the columns as limited by the controlling action. If the columns are shear critical, a shear mechanism forms at the shear capacity of the columns. If the columns are controlled by flexure, a flexural mechanism forms at a shear corresponding to the flexural capacity.

A IV.3.12 Beam Bars

The requirement for two continuous bars is a collapse prevention measure. In the event of complete beam failure, continuous bars will prevent total collapse of the supported floor, holding the beam in place by catenary action. Previous construction techniques used bent up longitudinal bars as reinforcement. These bars transitioned from bottom to top reinforcement at the gravity load inflection point. Some amount of continuous top and bottom reinforcement is desired because moments due to seismic forces can shift the location of the inflection point. Because non-compliant beams are vulnerable to collapse, the beams are required to resist demands at an elastic level.

A IV.3.13 Column Bar Splices

Located just above the floor level, column bar splices are typically located in regions of potential plastic hinge formation. Short splices are subject to sudden loss of bond. Widely

spaced ties can result in a spalling of the concrete cover and loss of bond. Splice failures are sudden and non-ductile.

A IV.3.14 Beam Bar Splices

Lap splices located at the end of beams and in vicinity of potential plastic hinges may not be able to develop the full moment capacity of the beam as the concrete degrades during multiple cycles.

A IV.3.15 Column Tie Spacing

Widely spaced ties will reduce the ductility of the column, and it may not be able to maintain full moment capacity through several cycles. Columns with widely spaced ties have limited shear capacity and non-ductile shear failures may result.

A IV.3.16 Stirrup Spacing

Widely spaced stirrups will reduce the ductility of the beam, and it may not be able to maintain full moment capacity through several cycles. Beams with widely spaced stirrups have limited shear capacity and non-ductile shear failures may result.

A IV.3.17 Joint Reinforcing

Beam-column joints without shear reinforcement may not be able to develop the strength of the connected members, leading to a non-ductile failure of the joint. Perimeter columns are especially vulnerable because the confinement of joint is limited to three sides (along the exterior) or two sides (at a corner).

A IV.3.18 Joint Eccentricity

Joint eccentricities can result in high torsional demands on the joint area, which will result in higher shear stresses.

A IV.3.19 Stirrup and Tie Hooks

To be fully effective, stirrups and ties must be anchored into the confined core of the member. 90° hooks that are anchored within the concrete cover are unreliable if the cover spalls during plastic hinging. The amount of shear resistance and confinement will be reduced if the stirrups and ties are not well anchored.

A IV.4 Unreinforced Masonry Shear Walls

A IV.4.1 Shear Stress Check

The shear stress check provides a quick assessment of the overall level of demand on the structure. The concern is the overall strength of the building.

A IV.4.2 Proportions

Slender un-reinforced masonry bearing walls with large height-to-thickness ratios have a potential for damage due to out-of-plane forces which may result in falling hazards and potential collapse of the structure.

A IV.4.3 Masonry Lay-up

When walls have poor collar joints, the inner and outer wythe will act independently. The walls may be inadequate to resist out-of-plane forces due to a lack of composite action between the inner and outer wythes. Mitigation to provide out-of-plane stability and anchorage of the wythes may be necessary to achieve the selected performance level.

A IV.5 Infill Walls in Frames

A IV.5.1 Wall Connections

Performance of frame buildings with masonry infill walls is dependent upon the interaction between the frame and infill panels. In-plane lateral force resistance is provided by a

compression strut developing in the infill panel that extends diagonally between corners of the frame. If gaps exist between the frame and infill, this strut cannot be developed. If the infill panels separate from the frame due to out-of-plane forces, the strength and stiffness of the system will be determined by the properties of the bare frame, which may not be detailed to resist seismic forces. Severe damage or partial collapse due to excessive drift and δ effects may occur.

A positive connection is needed to anchor the infill panel for out-of-plane forces. In this case, a positive connection can consist of a fully grouted bed joint in full contact with the frame, or complete encasement of the frame by the brick masonry.

A IV.5.2 Solid Walls

When the infill walls are of cavity construction, the inner and outer wythes will act independently due to a lack of composite action, increasing the potential for damage from out-of-plane forces. Out-of-plane failure of these walls will result in falling hazards and degradation of the strength and stiffness of the lateral force resisting system.

Mitigation to provide out-of-plane stability and anchorage of the wythes is necessary to achieve the selected performance level.

A IV.5.3 Infill Walls

Discontinuous infill walls occur when full bay windows or ventilation openings are provided between the top of the infill and bottom soffit of the frame beams. The portion of the column above the infill is a short captive column which may attract large shear forces due to increased stiffness relative to other columns. Partial infill walls will also develop compression struts with horizontal components that are highly eccentric to the beam column joints. If not adequately detailed, concrete columns may suffer a non-ductile shear failure which may result in partial collapse of the structure.

A column that can develop the shear capacity to develop the flexural strength over the clear height above the infill wall have some ductility to prevent sudden catastrophic failure of the vertical support system.

A IV.6 Factors Associated with Diaphragms

A IV.6.1 General

Diaphragms are horizontal elements that distribute seismic forces to vertical lateral force resisting elements. They also provide lateral support for walls and parapets. Diaphragm forces are derived from the self weight of the diaphragm and the weight of the elements and components that depend on the diaphragm for lateral support. Any roof, floor, or ceiling can participate in the distribution of lateral forces to vertical elements up to the limit of its strength. The degree to which it participates depends on relative stiffness and on connections. In order to function as a diaphragm, horizontal elements must be interconnected to transfer shear with connections that have some degree of stiffness.

An important characteristic of diaphragms is flexibility, or its opposite, rigidity. In seismic design, rigidity means relative rigidity. Of importance is the in-plane rigidity of the diaphragm relative to the walls or frame elements that transmit the lateral forces to the ground.

A IV.6.2 Diaphragm Continuity

Split level floors and roofs, or diaphragms interrupted by expansion joints, create discontinuities in the diaphragm. It is a problem unless special details are used, or lateral-force-resisting elements are provided at the vertical offset of the diaphragm or on both sides of the expansion joint. Such a discontinuity may cause the diaphragm to function as a cantilever element or three-sided diaphragm. If the diaphragm is not supported on at least three sides by lateral-force-resisting elements, torsional forces in the diaphragm may cause it

to become unstable.

A IV.6.3 Openings at Shear Walls and Exterior Masonry Shear Walls

Large openings at shear walls significantly limit the ability of the diaphragm to transfer lateral forces to the wall. This can have a compounding effect if the opening is near one end of the wall and divides the diaphragm into small segments with limited stiffness that are ineffective in transferring shear to the wall. Large openings may also limit the ability of the diaphragm to provide out-of-plane support for the wall.

A IV.6.4 Plan Irregularities

Diaphragms with plan irregularities such as extending wings, plan insets, or E-, T-, X-, L-, or C-shaped configurations have re-entrant corners where large tensile and compressive forces can develop. The diaphragm may not have sufficient strength at these re-entrant corners to resist these tensile forces and local damage may occur.

GUIDELINES

for Seismic Vulnerability Assessment of

HOSPITALS

Annex V: Vulnerability Factors Identification Checklist

A V.1	Vulnerability Factors Identification.....	53
A V.2	Structural Assessment Checklist for Type 1 Buildings (Adobe, Stone in Mud, Brick in Mud).....	53
A V.3	Structural Assessment Checklist for Type 2 Buildings (Brick in Cement Buildings and Stone in Cement Buildings).....	55
A V.4	Structural Assessment Checklist for Type 3 Buildings (Reinforced Concrete Ordinary-Moment-Resisting-Frame Buildings).....	57
A V.5	Structural Assessment Checklist for Type 4 and Type 5 Buildings (Reinforced Concrete Intermediate-Moment-Resisting-Frame and Special-Moment-Resisting-Frame Buildings).....	58

Annex V: Vulnerability Factors Identification Checklist

A V.1 Vulnerability Factors Identification

Appropriate checklists for different types of hospital buildings are given in this section. Checklists available for certain building types are taken from FEMA 310, *Handbook for the Seismic Evaluation of Buildings*, and checklists for other building types, which are not included in FEMA 310, are developed as per Nepal National Building Code. The checklists cover the basic vulnerability factors related to building systems, lateral force resisting systems, connections and diaphragms, which will mostly be evaluated based on visual observation.

A V.2 Structural Assessment Checklist for Type 1 Buildings (Adobe, Stone in Mud, Brick in Mud)

A V.2.1 Building System

- C NC N/A SHAPE: The building shall be symmetrical in plan and regular in elevation.
- C NC N/A PROPORTION IN PLAN: The breadth to length ratio of the building shall be within 1:3. The breadth to length ratio of any room or area enclosed by load bearing walls inside the building shall also be within 1:3. The building height shall be not more than three times the width of the building.
- C NC N/A STOREY HEIGHT: The floor to floor height of the building shall be between 2-3 m.
- C NC N/A NUMBER OF STORIES: The building shall be up to two stories only.
- C NC N/A FOUNDATION: The foundation width and depth shall be at least 75cm. Masonry units shall consist of flat-bedded stones or regular-sized well-burnt bricks. Mortar joints shall not exceed 20mm in any case. There shall be no mud-packing at the core of the foundation.
- C NC N/A SLOPING GROUND: The slope of the ground where the building lies shall not be more than 20° (1:3, vertical: horizontal).
- C NC N/A PLUMB LINE: Walls of the foundation and superstructure shall be true to the plumb line and the width of the wall shall be uniform.
- C NC N/A WALL CORE: There shall be no mortar packing at the core of the wall.
- C NC N/A THROUGH-STONES: In case of stone buildings, the walls shall have plenty of through-stones extending the whole width of the walls. The maximum spacing of such through-stones shall be within 1.2m horizontally and 0.6m vertically.
- C NC N/A WALL THICKNESS: The minimum wall thickness for different story heights shall not be less than:

Masonry Type	No of Stories	
	One	Two
Stone	340-450	450
Brick	230	350

- C NC N/A UNSUPPORTED WALL LENGTH: The maximum length of unsupported wall shall not be more than 12 times its thickness. If the length of unsupported wall is more than 12 times its thickness, buttressing shall be provided.
- C NC N/A HEIGHT OF WALLS: The thickness to height ratio of a wall shall not be more than 1:8 for stone buildings and 1:12 for brick buildings.

- C NC N/A OPENINGS IN WALLS: The maximum combined width of the openings in a wall between two consecutive cross-walls shall not be more than 35% of the total wall length for one-story buildings and not more than 25% of the total wall length in two-story buildings.
- C NC N/A POSITION OF OPENINGS: Openings shall not be located in corners or junctions of a wall. Openings shall not be placed closer to an internal corner of a wall than half the opening height or 1.5 times the wall thickness, whichever is greater. The width of pier between two openings shall not be less than half of the opening height or 1.5 times the wall thickness, whichever is greater. The vertical distance between two openings shall not be less than 0.6m or half the width of the smaller opening, whichever is greater.
- C NC N/A LOAD PATH: The structure shall contain one complete load path for Life Safety and Immediate Occupancy for seismic force effects from any horizontal direction that serves to transfer the inertial forces from the mass to the foundation.
- C NC N/A VERTICAL DISCONTINUITIES: All vertical elements in the lateral-force-resisting system shall be continuous to the foundation.
- C NC N/A MASS: There shall be no change in effective mass more than 50% from one story to the next.
- C NC N/A TORSION: The distance between the story center of mass and the story center of rigidity shall be less than 20% of the building width in either plan dimension.
- C NC N/A MASONRY UNITS: There shall be no visible deterioration of masonry units.
- C NC N/A WALL CRACKS: There shall be no existing diagonal cracks in wall elements greater than 1/16" or out-of-plane offsets in the bed joint greater than 1/16".
- C NC N/A MASONRY LAY-UP: Filled collar joints of multi-wythe masonry walls shall have negligible voids.
- C NC N/A VERTICAL REINFORCEMENT: There shall be vertical reinforcement in all corners and T-junctions of masonry walls and it shall be started from the foundation and continue to the roof.
- C NC N/A HORIZONTAL BANDS: There shall be steel or wooden bands located at the plinth, sill and lintel levels of the building in each floor.
- C NC N/A CORNER STITCH: There shall be reinforced concrete or wooden elements connecting two orthogonal walls at a vertical distance of at least 0.5m to 0.7m.
- C NC N/A GABLE BAND: If the roof is a sloped roof, a gable band shall be provided to the building.

A V.2.2 Lateral Force Resisting System

- C NC N/A REDUNDANCY: The number of lines of walls in each principal direction shall be greater than or equal to 2.

A V.2.3 Diaphragms

- C NC N/A DIAGONAL BRACING: All flexible structural elements of diaphragms such as joists and rafters shall be diagonally braced and each crossing of a joist / rafter and a brace shall be properly fixed.
- C NC N/A LATERAL RESTRAINERS: All joists and rafters shall be restrained by timber keys on both sides of wall.

A V.3 Structural Assessment Checklist for Type 2 Buildings (Brick in Cement Buildings and Stone in Cement Buildings)

A V.3.1 Building System

- C NC N/A LOAD PATH: The structure shall contain one complete load path for Life Safety and Immediate Occupancy for seismic force effects from any horizontal direction that serves to transfer the inertial forces from the mass to the foundation.
- C NC N/A WEAK STORY: The strength of the lateral-force-resisting system in any story shall not be less than 80% of the strength in an adjacent story above.
- C NC N/A SOFT STORY: The stiffness of the lateral-force-resisting system in any story shall not be less than 70% of the stiffness in an adjacent story above or below or less than 80% of the average stiffness of the three stories above or below.
- C NC N/A GEOMETRY: There shall be no changes in the horizontal dimension of the lateral-force-resisting system of more than 30% in a story relative to adjacent stories.
- C NC N/A VERTICAL DISCONTINUITIES: All vertical elements in the lateral-force-resisting system shall be continuous to the foundation.
- C NC N/A MASS: There shall be no change in effective mass more than 50% from one story to the next.
- C NC N/A TORSION: The distance between the story centre of mass and the story centre of rigidity shall be less than 20% of the building width in either plan dimension.
- C NC N/A DETERIORATION OF CONCRETE: There shall be no visible deterioration of concrete or reinforcing steel in any of the vertical- or lateral-force-resisting elements.
- C NC N/A MASONRY UNITS: There shall be no visible deterioration of masonry units.
- C NC N/A MASONRY JOINTS: The mortar shall not be easily scraped away from the joints by hand with a metal tool and there shall be no areas of eroded mortar.
- C NC N/A UNREINFORCED MASONRY WALL CRACKS: There shall be no existing diagonal cracks in wall elements greater than 1/16" or out-of-plane offsets in the bed joint greater than 1/16".
- C NC N/A PROPORTIONS: The height-to-thickness ratio of the shear walls at each story shall be less than the following for Life Safety and Immediate Occupancy:

Top story of multi-story building:	9
First story of multi-story building:	15
All other conditions:	13
- C NC N/A MASONRY LAY-UP: Filled collar joints of multi-wythe masonry walls shall have negligible voids.
- C NC N/A VERTICAL REINFORCEMENT: There shall be vertical reinforcement in all corners and T-junctions of masonry walls and it shall be started from the foundation and be continuous to the roof.
- C NC N/A HORIZONTAL BANDS: There shall be steel or wooden bands located at the plinth, sill and lintel levels of the building in each floor.
- C NC N/A CORNER STITCH: There shall be reinforced concrete or wooden elements

connecting two orthogonal walls at a vertical distance of at least 0.5m to 0.7m.

C NC N/A GABLE BAND: If the roof is a sloped roof, a gable band shall be provided to the building.

C NC N/A THROUGH-STONES: In case of stone buildings, the walls shall have plenty of through-stones extending the whole width of the walls. The maximum spacing of such through-stones shall be 1.2m horizontally and 0.6m vertically.

A V.3.2 Lateral Force Resisting System

C NC N/A REDUNDANCY: The number of lines of shear walls in each principal direction shall be greater than or equal to 2.

C NC N/A SHEAR STRESS CHECK: The shear stress in the un-reinforced masonry shear walls shall be less than 15 psi for clay units and 30 psi for concrete units.

A V.3.3 Diaphragms

C NC N/A OPENINGS IN SHEAR WALLS: Diaphragm openings immediately adjacent to the shear walls shall be less than 15% of the wall length.

C NC N/A OPENINGS IN EXTERIOR MASONRY SHEAR WALLS: Diaphragm openings immediately adjacent to exterior masonry shear walls shall not be greater than 4 ft. long.

C NC N/A PLAN IRREGULARITIES: There shall be tensile capacity to develop the strength of the diaphragm at re-entrant corners or other locations of plan irregularities

C NC N/A DIAPHRAGM REINFORCEMENT AT OPENINGS: There shall be reinforcing around all diaphragm openings larger than 50% of the building width in either major plan dimension.

C NC N/A DIAGONAL BRACING: If there is flexible diaphragms such as joists and rafters it shall be diagonally braced and each crossing of a joist / rafter and a brace shall be properly fixed.

C NC N/A LATERAL RESTRAINERS: For flexible roof and floors, all joists and rafters shall be restrained by timber keys on both sides of the wall.

A V.3.4 Connections

C NC N/A WALL ANCHORAGE: Exterior concrete or masonry walls shall be anchored for out-of-plane forces at each diaphragm level with steel anchors or straps that are anchored into the diaphragm.

C NC N/A TRANSFER TO SHEAR WALLS: Diaphragms shall be reinforced and connected for transfer of loads to the shear walls and the connections shall be able to develop the shear strength of the walls.

C NC N/A ANCHOR SPACING: Exterior masonry walls shall be anchored to the floor and roof systems at a spacing of 3 ft. or less.

A V.3.5 Additional Factors for Stone Buildings

C NC N/A NUMBER OF STORIES: The number of stories of a stone building shall be limited to 2.

C NC N/A UNSUPPORTED WALL LENGTH: The maximum unsupported length of a wall between cross-walls shall be limited to 5m.

A V.4 Structural Assessment Checklist for Type 3 Buildings (Reinforced Concrete Ordinary-Moment-Resisting-Frame Buildings)

A V.4.1 Building System

- C NC N/A **LOAD PATH:** The structure shall contain one complete load path for seismic force effects from any horizontal direction that serves to transfer the inertial forces from the mass to the foundation.
- C NC N/A **WEAK STORY:** The strength of the lateral-force-resisting system in any story shall not be less than 80% of the strength in an adjacent story above or below.
- C NC N/A **SOFT STORY:** The stiffness of the lateral-force-resisting system in any story shall not be less than 70% of the stiffness in an adjacent story above or below or less than 80% of the average stiffness of the three stories above or below.
- C NC N/A **GEOMETRY:** There shall be no changes in horizontal dimension of the lateral-force-resisting system of more than 30% in a story relative to adjacent stories.
- C NC N/A **VERTICAL DISCONTINUITIES:** All vertical elements in the lateral-force-resisting system shall be continuous to the foundation.
- C NC N/A **MASS:** There shall be no change in effective mass more than 50% from one story to the next.
- C NC N/A **TORSION:** The distance between the story center of mass and the story center of rigidity shall be less than 20% of the building width in either plan dimension.
- C NC N/A **DETERIORATION OF CONCRETE:** There shall be no visible deterioration of concrete or reinforcing steel in any of the vertical- or lateral-force-resisting elements.
- C NC N/A **MASONRY UNITS:** There shall be no visible deterioration of masonry units.
- C NC N/A **MASONRY JOINTS:** The mortar shall not be easily scraped away from the joints by hand with a metal tool and there shall be no areas of eroded mortar.
- C NC N/A **CRACKS IN INFILL WALLS:** There shall be no existing diagonal cracks in infill walls that extend throughout a panel, are greater than 1/16", or have out-of-plane offsets in the bed joint greater than 1/16".
- C NC N/A **CRACKS IN BOUNDARY COLUMNS:** There shall be no existing diagonal cracks wider than 1/16" in concrete columns that encase masonry infill.

A V.4.2 Lateral Force Resisting System

- C NC N/A **REDUNDANCY:** The number of lines of shear walls in each principal direction shall be greater than or equal to 2.
- C NC N/A **SHEAR STRESS CHECK:** The shear stress in the un-reinforced masonry shear walls shall be less than 15 psi for clay units and 30 psi for concrete units.
- C NC N/A **WALL CONNECTIONS:** All infill walls shall have a positive connection to the frame to resist out-of-plane forces and the connection shall be able to develop the out-of-plane strength of the wall.
- C NC N/A **DEFLECTION COMPATIBILITY:** Secondary components shall have the shear capacity to develop the flexural strength of the elements and shall have ductile detailing.
- C NC N/A **REINFORCING AT OPENINGS:** All wall openings that interrupt rebar shall

have trim reinforcing on all sides.

- C NC N/A PROPORTIONS: The height-to-thickness ratio of the infill walls at each story shall be less than 8.
- C NC N/A SOLID WALLS: The infill walls shall not be of cavity construction.
- C NC N/A INFILL WALLS: The infill walls shall be continuous to the soffits of the frame beams.

A V.4.3 Diaphragms

- C NC N/A DIAPHRAGM CONTINUITY: The diaphragms shall not be composed of split-level floors.
- C NC N/A OPENINGS IN SHEAR WALLS: Diaphragm openings immediately adjacent to the shear walls shall be less than 15% of the wall length.
- C NC N/A PLAN IRREGULARITIES: There shall be tensile capacity to develop the strength of the diaphragm at re-entrant corners or other locations of plan irregularities.
- C NC N/A DIAPHRAGM REINFORCEMENT AT OPENINGS: There shall be reinforcing around all diaphragm openings larger than 50% of the building width in either major plan dimension.

A V.4.4 Connections

- C NC N/A TRANSFER TO SHEAR WALLS: Diaphragms shall be reinforced and connected for transfer of loads to the shear walls and the connections shall be able to develop the shear strength of the walls.
- C NC N/A CONCRETE COLUMNS: All concrete columns shall be doweled into the foundation and the dowels shall be able to develop the tensile capacity of the column.

A V.5 **Structural Assessment Checklist for Type 4 and Type 5 Buildings (Reinforced Concrete Intermediate-Moment-Resisting-Frame and Special-Moment-Resisting-Frame Buildings)**

A V.5.1 Building System

- C NC N/A LOAD PATH: The structure shall contain one complete load path for seismic force effects from any horizontal direction that serves to transfer the inertial forces from the mass to the foundation.
- C NC N/A ADJACENT BUILDINGS: Adjacent buildings shall not be located next to the structure being evaluated at a distance closer than 4% of the height.
- C NC N/A WEAK STORY: The strength of the lateral-force-resisting system in any story shall not be less than 80% of the strength in an adjacent story above or below.
- C NC N/A SOFT STORY: The stiffness of the lateral-force-resisting system in any story shall not be less than 70% of the stiffness in an adjacent story above or below or less than 80% of the average stiffness of the three stories above or below.
- C NC N/A GEOMETRY: There shall be no changes in the horizontal dimension of the lateral-force-resisting system of more than 30% in a story relative to adjacent stories.
- C NC N/A VERTICAL DISCONTINUITIES: All vertical elements in the lateral-force-resisting system shall be continuous to the foundation.
- C NC N/A MASS: There shall be no change in effective mass more than 50% from one

story to the next.

- C NC N/A TORSION: The distance between the story center of mass and the story center of rigidity shall be less than 20% of the building width in either plan dimension.
- C NC N/A DETERIORATION OF CONCRETE: There shall be no visible deterioration of concrete or reinforcing steel in any of the vertical- or lateral-force-resisting elements.

A V.5.2 Lateral Force Resisting System

- C NC N/A REDUNDANCY: The number of lines of moment frames in each principal direction shall be greater than or equal to 2. The number of bays of moment frames in each line shall be greater than or equal to 3.
- C NC N/A INTERFERING WALLS: All infill walls placed in moment frames shall be isolated from structural elements.
- C NC N/A SHEAR STRESS CHECK: The shear stress in the concrete columns shall be less than 100 psi or $2\sqrt{f'_c}$.
- C NC N/A AXIAL STRESS CHECK: The axial stress due to gravity loads in columns subjected to overturning forces calculated using the Quick Check shall be less than $0.10 f'_c$. Alternatively, the axial stresses due to overturning forces alone, calculated using the Quick Check shall be less than $0.30 f'_c$.
- C NC N/A FLAT SLAB FRAMES: The lateral-force-resisting system shall not be a frame consisting of columns and a flat slab / plate without beams.
- C NC N/A SHORT CAPTIVE COLUMNS: There shall be no columns at a level with height / depth ratios less than 75% of the nominal height / depth ratio of the typical columns at that level.
- C NC N/A NO SHEAR FAILURES: The shear capacity of frame members shall be able to develop the moment capacity at the top and bottom of the columns.
- C NC N/A STRONG COLUMN / WEAK BEAM: The sum of the moment capacity of the columns shall be 20% greater than that of the beams at frame joints.
- C NC N/A BEAM BARS: At least two longitudinal top and two longitudinal bottom bars shall extend continuously throughout the length of each frame beam. At least 25% of the longitudinal bars provided at the joints for either positive or negative moment shall be continuous throughout the length of the members.
- C NC N/A COLUMN-BAR SPLICES: All column bar lap splice lengths shall be greater than $50 d_b$ and shall be enclosed by ties spaced at or less than $8 d_b$.
- C NC N/A BEAM-BAR SPLICES: The lap splices for longitudinal beam reinforcing shall not be located within $l_b/4$ of the joints and shall not be located within the vicinity of potential plastic hinge locations.
- C NC N/A COLUMN-TIE SPACING: Frame columns shall have ties spaced at or less than $d/4$ throughout their length and at or less than $8 d_b$ at all potential plastic hinge locations.
- C NC N/A STIRRUP SPACING: All beams shall have stirrups spaced at or less than $d/2$ throughout their length. At potential plastic hinge locations stirrups shall be spaced at or less than the minimum of $8 d_b$ or $d/4$.
- C NC N/A JOINT REINFORCING: Beam-column joints shall have ties spaced at or less than $8d_b$.

- C NC N/A JOINT ECCENTRICITY: There shall be no eccentricities larger than 20% of the smallest column plan dimension between girder and column centre lines.
- C NC N/A STIRRUP AND TIE HOOKS: The beam stirrups and column ties shall be anchored into the member cores with hooks of 135° or more.
- C NC N/A DEFLECTION COMPATIBILITY: Secondary components shall have the shear capacity to develop the flexural strength of the elements and shall have ductile detailing.

A V.5.3 Diaphragms

- C NC N/A DIAPHRAGM CONTINUITY: The diaphragms shall not be composed of split-level floors.
- C NC N/A PLAN IRREGULARITIES: There shall be tensile capacity to develop the strength of the diaphragm at re-entrant corners or other locations of plan irregularities.
- C NC N/A DIAPHRAGM REINFORCEMENT AT OPENINGS: There shall be reinforcing around all diaphragm openings larger than 50% of the building width in either major plan dimension.

A V.5.4 Connections

- C NC N/A CONCRETE COLUMNS: All concrete columns shall be doweled into the foundation and the dowels shall be able to develop the tensile capacity of the column.

GUIDELINES

for Seismic Vulnerability Assessment of

HOSPITALS

Annex VI: Quick Checks

A VI.1	Calculation for Shear Stress Check.....	64
A VI.2	Axial Stress Check.....	65
A VI.3	Check for Torsion.....	66

List of Figure

Figure A-VI. 1:	Typical floor plan of a building under consideration.....	63
------------------------	--	-----------

Annex VI: Quick Checks

The following is a sample of quick check calculations based on FEMA 310 for the seismic evaluation of a building under consideration.

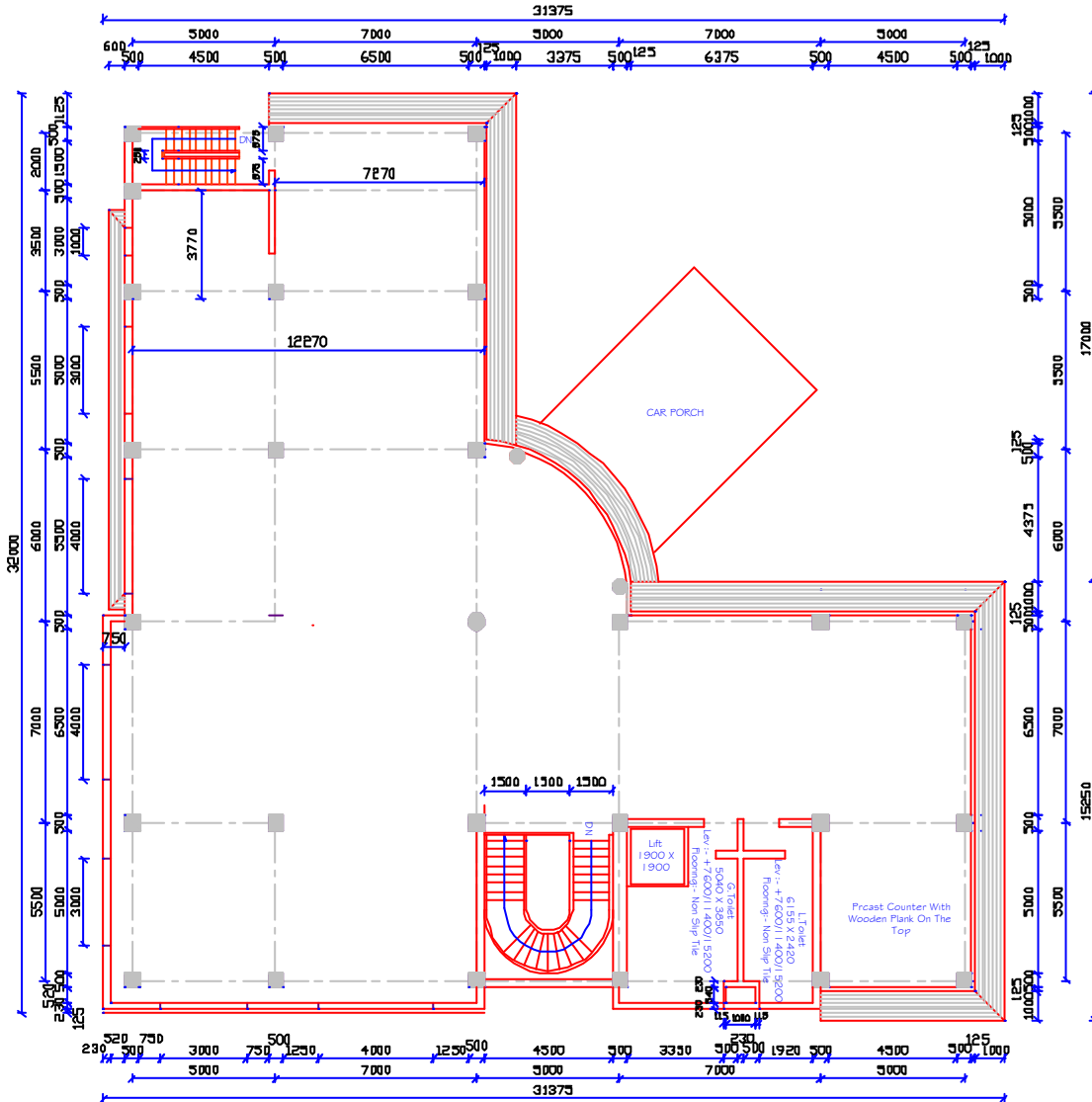

Figure A-VI. 1: Typical floor plan of a building under consideration

Building Description

The building chosen has a reinforced concrete frame with rigid floor diaphragm. The building has five stories with a basement and is L shaped above ground level. The basement is used for vehicle parking. The building is designed for a high seismic zone. Some of the dimensional parameters are as follows

- Base width = 12m
- Base length = 30m
- Basement floor height = 5.0m

Floor height of the rest of the floors = 3.8m

Assumptions:

Unit weight of RCC = 25kN/m³; unit weight of brick = 19 kN/m³

Live load = 3.0 kN/m²; live load at roof level = 1.5 kN/ m²

A VI.1 Calculation for Shear Stress Check

A VI.1.1 Summary of lumped load calculation

S.N.	Description	Load (kN)						
		Ground	First	Second	Third	Fourth	Roof	Total
1	Dead Load	12605.07	5904	5884	5884	5884	4728	
2	Live Load	6088.5	1800	2052	2052	2052	1185	
3	% Live Load	1522.125	450	513	513	513	296.25	
4	Seismic wt.	7610.625	2250	2565	2565	2565	1481.25	19036.875

A VI.1.2 Calculation of base shear (using IS 1893:2002)

The total design lateral force or design seismic base shear is given by

$$V_b = A_h W$$

Where,

A_h = Design horizontal acceleration = $Z I S_a / 2 R g$

Z= Zone factor= 0.36

I= Importance factor= 1.5

S_a/g = Average response acceleration coefficient = 2.5 for T=0.34

R = Response reduction factor=3.0

W= Total seismic wt. of the building = 19036.875 KN

$V_b = 4283.2969 \text{ KN}$

A VI.1.3 Distribution of base shear and calculation of story shear

The design base shear (V_b) is distributed along the height of the building as per the following expression:

$$Q_i = V_b (W_i h_i^2 / \sum W_i h_i^2)$$

Where

Q_i = Design lateral force at floor i

W_i = Seismic weight of floor i

h_i = Height of floor i measured from base

Floor	Total weight W_i (kN)	Height h_i (m)	$W_i h_i^2$	Q_i (kN)	Story Shear V_j (kN)
Ground	7610.625	5.0	190265.6	242.4457	4283.297
First	2250	8.8	174240	222.025	4040.851
Second	2565	12.6	407219.4	518.8987	3818.826

Third	2565	16.4	689882.4	879.0816	3299.927
Fourth	2565	20.2	1046623	1333.657	2420.846
Roof	1481.25	24	853200	1087.189	1087.189

A VI.1.4 Calculation of average shear stress as per FEMA 310

Level	Story Shear V_j (kN)	V_j (P)	A_c (in ²)	n_c	n_f	n_c-n_f	Shear Stress V_{avg} (psi)
Ground	4283.297	942325.3	24663.75	63	8	55	33.66481
First	4040.851	888987.3	14071.75	30	6	24	60.74549
Second	3818.826	840141.8	13028.39	30	6	24	62.00525
Third	3299.927	725984	11620.39	30	6	24	60.07213
Fourth	2420.846	532586.1	11620.39	30	6	24	44.06926
Roof	1087.189	239181.5	11620.39	30	6	24	19.79127

Where,

A_c = Summation of the cross sectional area of all columns in the story under consideration

n_c = Total no. of columns

n_f = Total no. of frames in the direction of loading

V_{avg} = Average shear stress (psi) in the columns of concrete frames

$$= (1/m) (n_c / n_c - n_f) (V_j / A_c)$$

m = component modification factor = 1.3 for buildings being evaluated to the immediate occupancy performance level

The average induced shear stresses are less than the permissible value of 100psi or $2 \sqrt{f_c'}$ (107.6)

Hence safe

A VI.2 Axial Stress Check

A VI.2.1 Axial due to gravity loads in columns

Permissible axial value = 289.66 psi ($0.1 f_c'$)

Level	Axial Load (KN)	Axial Load (P)	A_c (in ²)	Axial Stress(psi)
Ground	7610.625	1674337.5	24663.75	67.88 (Hence safe)
First	2250	495000	14071.75	35.2 (Hence safe)

A VI.2.2 Axial stresses due to overturning forces as per FEMA 310

Permissible shear = 868.8 psi ($0.3 f_c'$)

The axial stress of columns subjected to overturning forces P_{ot} is given by

$$P_{ot} = (1/m) (2/3) (V h_n / L n_f) (1/ A_c)$$

Where,

n_f = Total no. of frames in the direction of loading =6

V = Base shear = 4283.3 KN = 942325.3 P

h_n = Height (in feet) above the base to the roof level = 24m = 80 ft

$L = \text{Total length of the frame (in feet)} = 100\text{ft.}$

$m = \text{Component modification factor} = 1.3$

$A_c = \text{Summation of the cross sectional area of all columns in the storey under consideration} = 24663.75 \text{ in}^2$

$P_{ot} = 2.6 \text{ psi} < 868.8 \text{ psi}$

Hence Safe

A VI.3 Check for Torsion

A VI.3.1 Calculation for locating centre of mass and centre of rigidity

S.N.	Column size (mm)	Moment of Inertia(I)mm ⁴	Stiffness $K=12EI/L^3$	Nos.	Total I
1	600X600	0.0108	$0.0108(12E/L^3)$	13	0.1404
2	500X500	0.00521	$0.00521(12E/L^3)$	13	0.0677
3	400X400	0.00213	$0.00213(12E/L^3)$	1	0.0021
4	700 Dia.	0.01179	$0.01179(12E/L^3)$	1	0.0118
5	350 Dia.	0.00074	$0.00074(12E/L^3)$	2	0.0015
				30	0.2235

Centre of rigidity

$0.2235 X = 3.6 \quad X = 16.123 \text{ m}$

$0.2235 Y = 2.593 \quad Y = 11.6 \text{ m}$

Centre of mass

$X = 17.927 \text{ m}$

$Y = 11.45 \text{ m}$

The distance between the story centre of mass and the story centre of rigidity is less than 20% of the building width, i.e. 2.4m (20% of 12m).

Hence Safe

GUIDELINES
for Seismic Vulnerability Assessment of
HOSPITALS

Annex VII: List of Most Common Equipment in Hospitals

Annex VII: List of Most Common Equipment in Hospitals

S.N.	Name of Equipment	S.N.	Name of Equipment
1	Anesthesia machine with ventilator	38	Laparoscopy equipment
2	Autoclave	39	Lontofor equipment
3	Automatic cell counter	40	Microcentrifuge
4	Bilirubin meter	41	Microscopes
5	Biochemical analyzer	42	Miscellaneous equipment
6	Blood bank freezer	43	MRI machine
7	Boilers	44	Operating table
8	Centrifuge	45	Osmometers
9	Circuit Boards	46	Ovens
10	Clinical files	47	Oxygen concentrator
11	CT scanner	48	Oxygen Cryogenic tank
12	Culture incubator	49	Oxygen cylinders
13	Dialysis unit	50	Oxygen Tanks
14	Dryers	51	Pavilion lamp
15	Electrical photometer	52	Piping
16	Electrocardiogram defibrillator monitor	53	Plate developers
17	Electrodiathermy	54	Plate processing equipment
18	Electrostimulator	55	Power generator
19	Elevator controls	56	Pulmonary function analyzer
20	Elevator engine	57	Pulse oxymeter
21	Elevator pulleys	58	Respirators
22	ELISA analyzer	59	Shelves
23	Emergency power generator	60	Steam system
24	Ethylene oxide sterilizer	61	Sterile and non-sterile material storage
25	Flame photometer	62	Suction machine and pumps
26	Gamma chambers	63	Telephone switchboard
27	Gas analyzer	64	Transformer
28	Gas Connection	65	Ultrasound
29	Gas cookers	66	Urine analyzer
30	Geiger counter	67	Vital signs monitors
31	Hemodialysis machines	68	Washing machines
32	Image intensifier	69	Waste disposal
33	Incubator	70	Water pump system
34	Industrial freezer	71	Water tanks
35	Infusion pump	72	X-ray equipment
36	Kitchen equipment		
37	Lamp		

GUIDELINES

for Seismic Vulnerability Assessment of

HOSPITALS

Annex VIII: Rapid Visual Screening Reference

A VIII.1	Transformers	74
A VIII.2	Control Panels for Generators	75
A VIII.3	Distribution Boxes and Distribution Panels	76
A VIII.4	Batteries and Racks	77
A VIII.5	Generators	78
A VIII.6	Communications Control Equipment	79
A VIII.7	Medical Lab and Medical Unit Equipment	80
A VIII.8	Blood Bank Refrigerators	81
A VIII.9	Pumps	82
A VIII.10	Compressors and Vacuum	83
A VIII.11	Tanks on legs and skirts	84
A VIII.12	Horizontal Tanks	85
A VIII.13	Anchored Vertical Tanks	86
A VIII.14	Fire Protection Equipment	87

Annex VIII: Rapid Visual Screening References

Fourteen rapid visual screening references are given in this annex. Each reference provides the risk rating of different types of components in relation to size of earthquakes, location in the building and different vulnerability factors. Risk is categorized as Low, Moderate, High and Very High where Low means that the equipment is safe and Very High that it is highly vulnerable and needs appropriate improvement to achieve safety levels. These references have been developed based on the Rapid Visual Screening Score Sheet given in *Seismic Reliability Assessment of Critical Facilities: A handbook, Supporting Documentation, and Model Code Provisions, Technical report MCEER-99-008* for similar types of equipment. Only a limited number of references are given in this guideline, and it is necessary to develop more references of a similar kind in the future in order to facilitate the assessment process.

However, these score sheets can also be used to evaluate other components of a similar physical nature. The list of rapid visual screening references given in this annex is as follows:

1. Transformers
2. Control Panels for Generators
3. Distribution Boxes and Distribution Panels
4. Batteries and Racks
5. Generators
6. Communications Control Equipment
7. Medical Lab and Medical Unit Equipment
8. Blood Bank Refrigerators
9. Pumps
10. Compressors and Vacuum
11. Tanks on Legs and Skirts
12. Horizontal Tanks
13. Anchored Vertical Tanks
14. Fire Protection Equipment

A VIII.1 Transformers



S.N.	Description	Moderate Earthquake			Severe Earthquake		
		Location in the Building			Location in the Building		
		Bottom Third	Middle Third	Top Third	Bottom Third	Middle Third	Top Third
	<i>Basic Risk</i>	<i>Low</i>	<i>Moderate</i>	<i>Moderate</i>	<i>Moderate</i>	<i>Moderate</i>	<i>High</i>
1	No anchorage	High	High	Very High	High	Very High	Very High
2	“Poor” anchorage	High	High	Very High	High	Very High	Very High
3	Pounding / impact concerns	Moderate	Moderate	High	Moderate	High	High
4	Poor load path	Moderate	High	High	High	High	Very High
5	Interaction concerns	Moderate	High	High	High	High	Very High
6	Coils not firmly restrained	High	High	High	High	High	Very High
7	Other_____						
8	Other_____						

Choosing Appropriate Risk Level

- 1,2 If there is no anchorage, choose 1. If the anchorage appears small compared to the size of the transformer, select 2.
3. If adjacent cabinets are not attached and are within approximately 1/2” of each other there is a risk of pounding between the two. If so, select 3.
4. The typical channel supports for transformers have some weakness from side-to-side loading. If thin gage sheet metal is used at the base, select 4.
5. If large items such as non-structural walls could fall and impact on the transformer, select 5.
6. Internal coils are sometimes only temporarily anchored for transportation and these bolts may be removed. If the coils are unrestrained, or are flexible and unbraced and of such a size that the coils could displace and short out, select 6.
7. For other conditions, choose the appropriate level of risk and add a descriptive statement for the concern.

A VIII.2 Control Panels for Generators



S.N.	Description	Moderate Earthquake			Severe Earthquake		
		Location in the Building			Location in the Building		
		Bottom Third	Middle Third	Top Third	Bottom Third	Middle Third	Top Third
	<i>Basic Risk</i>	<i>Low</i>	<i>Low</i>	<i>Moderate</i>	<i>Low</i>	<i>Moderate</i>	<i>Moderate</i>
1	No anchorage	High	High	Very High	High	Very High	Very High
2	“Poor” anchorage	High	High	Very High	High	Very High	Very High
3	Suspect Load Path	High	High	Very High	High	Very High	Very High
4	Pounding / impact concerns	Moderate	Moderate	High	Moderate	High	High
5	Inflexible attachment	High	High	Very High	High	Very High	Very High
6	Interaction concerns	High	Very High	Very High	Very High	Very High	Very High
7	Other_____						
8	Other_____						

Choosing Appropriate Risk Level

- 1,2 If there is no anchorage choose 1. If the anchorage appears small compared to the size of the transformer, select 2.
3. There should be a definite and continuous load path from the internal components of the panel to the anchorage at the base. If there are concerns regarding the integrity of the load path select 3.
4. If adjacent cabinets are not attached and are within about 1/2” of each other, there is a potential for pounding between the two. This is an issue for control cabinets, as they tend to contain shaking or impact sensitive devices, such as relays. Select 4.
5. If large items, such as non-structural walls, could fall and impact the panel, select 5.
6. For other conditions, choose the appropriate level of risk and add a descriptive statement for the concern.

A VIII.3 Distribution Boxes and Distribution Panels



S.N.	Description	Moderate Earthquake			Severe Earthquake		
		Location in the Building			Location in the Building		
		Bottom Third	Middle Third	Top Third	Bottom Third	Middle Third	Top Third
	<i>Basic Risk</i>	<i>Low</i>	<i>Low</i>	<i>Low</i>	<i>Low</i>	<i>Low</i>	<i>Moderate</i>
1	No anchorage	High	High	Very High	High	Very High	Very High
2	“Poor” anchorage	High	High	High	High	High	Very High
3	Pounding / impact concerns	Moderate	Moderate	High	Moderate	High	High
4	Interaction concerns	Moderate	Moderate	High	Moderate	High	High
5	Other _____						
6	Other _____						
7	Other _____						

Choosing Appropriate Risk Level

- 1,2 Select 1 if there is no anchorage. If the anchorage appears small compared to the size of the panel, or is damaged, select 2.
- 3 If adjacent cabinets are not attached and are within 1/2" of each other, there is a potential for pounding between the two. If so, select 3.
- 4 If large items, such as non-structural walls, could fall and impact on the panel, 4 should be selected.
- 5 For other conditions that the evaluator believes could inhibit the distribution panel function following an earthquake (e.g. a history of problems with this piece of equipment), choose the appropriate risk level and add a descriptive statement for the concern.

A VIII.4 Batteries and Racks

S.N.	Description	Moderate Earthquake			Severe Earthquake		
		Location in the Building			Location in the Building		
		Bottom Third	Middle Third	Top Third	Bottom Third	Middle Third	Top Third
	<i>Basic Risk</i>	Low	Low	Low	Low	Low	Moderate
1	No anchorage	High	High	Very High	High	Very High	Very High
2	“Poor” anchorage	High	High	High	High	High	Very High
3	No battery spacers	High	High	Very High	High	Very High	Very High
4	No longitudinal cross-bracing	High	High	High	High	High	Very High
5	No battery restraints	High	High	Very High	High	Very High	Very High
6	Interaction concerns	High	High	Very High	High	Very High	Very High
7	Other_____						
8	Other_____						

Choosing Appropriate Risk Level

- 1,2 If there are no anchor bolts at the base of the frame, select 1. If the anchors appear to be undersized, if there are not anchors for every frame of the rack, or if the anchorage appears to be damaged, select 2.
- 3 Look for stiff spacers between the batteries such as styrofoam that fits snugly in order to prevent battery pounding. If there are none, select 3.
- 4 The rack should provide restraints ensuring that the batteries cannot fall off. Select 4 if adequate restraint is not provided.
- 5 Racks with long rows of batteries need to be sufficiently stiff of braced longitudinally. Select 5 if no cross bracing is present.
- 6 If large items such as non-structural walls could fall and impact on the battery racks, select 6.
- 7 For other conditions choose the appropriate risk level and add a descriptive statement for the concern.

A VIII.5 Generators



S.N.	Description	Moderate Earthquake			Severe Earthquake		
		Location in the Building			Location in the Building		
		Bottom Third	Middle Third	Top Third	Bottom Third	Middle Third	Top Third
	<i>Basic Risk</i>	<i>Low</i>	<i>Low</i>	<i>Moderate</i>	<i>Low</i>	<i>Moderate</i>	<i>Moderate</i>
1	No anchorage	High	High	High	High	High	Very High
2	“Poor” anchorage	Moderate	High	High	High	High	Very High
3	Vibration isolator concerns	Moderate	High	High	High	High	Very High
4	Rigid attachment concerns	High	High	Very High	High	Very High	Very High
5	Driver/generator diff. Displacement	High	High	Very High	High	Very High	Very High
	Interaction concerns	Moderate	High	High	High	High	Very High
	Other_____						
	Other_____						

Choosing Appropriate Risk Level

- 1,2 Select 1 if there is no anchorage. If the anchorage appears small compared to the size of the generator, or is damaged, select 2.
- 3 Where vibration isolators are used there should be lateral and uplift restraints. If no restraints exist or they appear to be inadequate, select 3.
- 4 If attached conduits do not have adequate flexibility to accommodate potential generator motions, select 4.
- 5 The driver and the motor should be mounted on the same skid, if they are not, select 5.
- 6 If large items, such as non-structural walls, could fall and impact on the generator, 6 should be selected.
- 7 For other conditions choose the appropriate risk level and add a descriptive statement for the concern.

A VIII.6 Communications Control Equipment



S.N.	Description	Moderate Earthquake			Severe Earthquake		
		Location in the Building			Location in the Building		
		Bottom Third	Middle Third	Top Third	Bottom Third	Middle Third	Top Third
	<i>Basic Risk</i>	<i>Low</i>	<i>Low</i>	<i>Low</i>	<i>Low</i>	<i>Low</i>	<i>Low</i>
1	There is nothing to prevent overturning of the unit (unless it is of such size and weight that overturning is unlikely)	High	High	Very High	High	Very High	Very High
2	There is a significant interaction hazard from something falling on this equipment	High	High	Very High	High	Very High	Very High
3	Other_____						
4	Other_____						
5	Other_____						

Choosing Appropriate Risk Level

- 1 If the unit is unrestrained and unanchored and is tall and slender (such that it is likely to tip rather than slide), select 1.
- 2 If there are nearby hazards that can fall on the equipment and cause damage (heavy light fixtures, bookcases, etc.) select 2.
- 3 For other conditions that the evaluator believes could inhibit function following an earthquake, assign a risk level relative to the existing levels in the table. Add a descriptive statement for the concern.

A VIII.7 Medical Lab and Medical Unit Equipment



S.N.	Description	Moderate Earthquake			Severe Earthquake		
		Location in the Building			Location in the Building		
		Bottom Third	Middle Third	Top Third	Bottom Third	Middle Third	Top Third
	<i>Basic Risk</i>	<i>Low</i>	<i>Low</i>	<i>Low</i>	<i>Low</i>	<i>Low</i>	<i>Low</i>
1	Medical lab items are not secured to counters and tables	High	High	Very High	High	Very High	Very High
2	Medical lab items are stored on counters, tables, or carts that are likely to collapse	Moderate	High	High	High	High	Very High
3	Other_____						
4	Other_____						
5	Other_____						

Choosing Appropriate Risk Level

- 1 If items are unrestrained and can slide and fall in an earthquake, select 1.
- 2 If the table or other items holding the equipment does not appear to be strong enough to resist lateral loads from an earthquake without collapsing, select 2.
- 3 For other conditions that the evaluator believes could inhibit function following an earthquake, assign a risk level value relative to the existing level in the table. Add a descriptive statement for the concern.

A VIII.8 Blood Bank Refrigerators



S.N.	Description	Moderate Earthquake			Severe Earthquake		
		Location in the Building			Location in the Building		
		Bottom Third	Middle Third	Top Third	Bottom Third	Middle Third	Top Third
	<i>Basic Risk</i>	<i>Low</i>	<i>Low</i>	<i>Low</i>	<i>Low</i>	<i>Low</i>	<i>Low</i>
1	There is nothing to prevent overturning of the unit (unless it is of such a size and weight that overturning is unlikely)	Moderate	High	High	High	High	Very High
2	Other _____						
3	Other _____						
4	Other _____						
5	Other _____						
6	Other _____						

Choosing Appropriate Risk Level

- 1 If the unit is unrestrained and unanchored and is tall and slender (such that it is likely to tip rather than slide), select 1.
- 2,3 For other conditions that the evaluator believes could inhibit function following an earthquake, assign a risk level relative to the existing levels in the table. Add a descriptive statement for the concern.

A VIII.9 Pumps



S.N.	Description	Moderate Earthquake			Severe Earthquake		
		Location in the Building			Location in the Building		
		Bottom Third	Middle Third	Top Third	Bottom Third	Middle Third	Top Third
	<i>Basic Risk</i>	<i>Moderate</i>	<i>Moderate</i>	<i>High</i>	<i>Moderate</i>	<i>High</i>	<i>High</i>
1	No anchorage	High	Very High	Very High	Very High	Very High	Very High
2	“Poor” anchorage	High	Very High	Very High	Very High	Very High	Very High
3	Vibration isolator concerns	High	Very High	Very High	Very High	Very High	Very High
4	Motor / pump displacement	Very High	Very High	Very High	Very High	Very High	Very High
5	Piping support concerns	Very High	Very High	Very High	Very High	Very High	Very High
6	Interaction concerns	High	Very High	Very High	Very High	Very High	Very High
7	Other_____						
8	Other_____						

Choosing Appropriate Risk Level

- 1,2 Select 1 if there is no anchorage of the motor or pump to the skid, or of the skid to the pad. If the anchorage appears small compared to the size of the pump, or is damaged, select 2.
- 3 Where vibration isolators are used there should be lateral restraints. If no lateral restraints exist, or they appear to be inadequate, select 3.
- 4 The motor and pump should be mounted on a common skid or pad to reduce the risk of differential displacement. Select 4 if they are not.
- 5 Attached piping should be well supported to prevent excessive load transfer to the pump. If long, unsupported runs of piping terminate at the pump, select 5.
- 6 If large items, such as non-structural walls, could fall and impact on the pump, 6 should be selected.
- 7 For other conditions that the evaluator believes could inhibit pump function following an earthquake (e.g. a history of problems with this piece of equipment), assign a risk level relative to the existing levels in the table. Add a descriptive statement for the concern.

A VIII.10 Compressors and Vacuum



S.N.	Description	Moderate Earthquake			Severe Earthquake		
		Location in the Building			Location in the Building		
		Bottom Third	Middle Third	Top Third	Bottom Third	Middle Third	Top Third
	<i>Basic Risk</i>	<i>Low</i>	<i>Low</i>	<i>Low</i>	<i>Low</i>	<i>Low</i>	<i>Moderate</i>
1	No anchorage	High	Very High	Very High	Very High	Very High	Very High
2	“Poor” anchorage	High	High	Very High	High	Very High	Very High
3	Vibration isolator concerns	Moderate	High	High	High	High	Very High
4	Rigid attachment concerns	Moderate	High	High	High	High	Very High
5	Interaction concerns	Moderate	Moderate	High	Moderate	High	High
6	Other _____						
7	Other _____						

Choosing Appropriate Risk Level

- 1,2 Select 1 if there is no anchorage. If the anchorage appears small compared to the size of the compressor, or is damaged, select 2.
- 3 Where vibration isolators are used there should be lateral and uplift restraints. If no restraints exist, or they appear to be inadequate, select 3.
- 4 If attached conduits or pipes do not have sufficient flexibility to accommodate potential compressor displacement, select 4.
- 5 If large items, such as non-structural walls, could fall and impact on the compressor, 5 should be selected.
- 6 For other conditions that the evaluator believes could inhibit compressor function following an earthquake (e.g. a history of problems with this piece of equipment), assign a risk level relative to the existing levels in the table. Add a descriptive statement for the concern.

A VIII.11 Tanks on legs and skirts



S.N.	Description	Moderate Earthquake			Severe Earthquake		
		Location in the Building			Location in the Building		
		Bottom Third	Middle Third	Top Third	Bottom Third	Middle Third	Top Third
	<i>Basic Risk</i>	<i>Moderate</i>	<i>Moderate</i>	<i>High</i>	<i>Moderate</i>	<i>High</i>	<i>High</i>
1	Tank is unanchored or the anchorage is in poor condition	High	High	Very High	High	Very High	Very High
2	If anchored to a skid, the skid is unanchored	Moderate	High	High	High	High	Very High
3	Attached piping is too rigid to withstand expected displacement	High	High	Very High	High	Very High	Very High
4	Legs appear to be undersized for the weight of the tank, or the skirt has un-reinforced openings	High	High	Very High	High	Very High	Very High
5	Other _____						
6	Other _____						

Choosing Appropriate Risk Level

- 1 Tanks should be anchored and the anchorage should be in good condition (e.g. no heavy corrosion, no significant concrete cracks around the bolts). If not, select 1.
- 2 If the tank is anchored to a skid and the skid is not anchored, select 2.
- 3 Even for anchored tanks, there is a potential for significant motion during a seismic event. If the piping attached to the tank is too rigid to survive the expected displacement, select 3. An example may be a straight run of pipe from the top of the tank to an anchor point on a pipe way.
- 4 Supporting legs or skirts may be insufficient to prevent collapse under lateral loads. If tank supports appear inadequate, select 4. This risk level should also be used if the tank has un-reinforced openings. This can happen if piping penetrations are not at the designed locations and field modifications have been made during installation.
- 5 For other conditions that the evaluator believes could inhibit tank function following an earthquake (e.g. a history of problems with this tank), assign a risk level relative to the existing levels in the table. Add a descriptive statement for the concern.

A VIII.12 Horizontal Tanks

S.N.	Description	Moderate Earthquake			Severe Earthquake		
		Location in the Building			Location in the Building		
		Bottom Third	Middle Third	Top Third	Bottom Third	Middle Third	Top Third
	<i>Basic Risk</i>	<i>Low</i>	<i>Low</i>	<i>Low</i>	<i>Low</i>	<i>Low</i>	<i>Moderate</i>
1	Vessel is unanchored or the anchorage is in poor condition	Moderate	High	High	High	High	Very High
2	Tank is not attached to the saddle	High	High	Very High	High	Very High	Very High
3	Attached piping is too rigid to withstand expected displacement	High	High	High	High	High	Very High
4	Shells of stacked heat exchangers are not secured together	High	High	Very High	High	Very High	Very High
5	Other_____						
6	Other_____						
7	Other_____						
8	Other_____						

Choosing Appropriate Risk Level

1. Tanks should be anchored and the anchorage should be in good condition (e.g. no heavy corrosion, no significant concrete cracks around the bolts). If not, select 1.
2. If the tank is not attached to its saddle, it could slide or rock in an earthquake. If this motion could cause damage, select 2. Be especially aware of any piping connections, drain taps, etc. that could be impacted by the tank if it slides.
3. Even for anchored tanks, there is a potential for significant motion during a seismic event. If the piping attached to the tank is too rigid to survive the expected displacement, select 3. An example may be a straight run of pipe from the top of the tank to an anchor point on a pipe way.
4. Vertically stacked heat exchangers should be positively attached to each other. If they are not, select 4. This may occur when bolts are removed and not reinstalled during maintenance.
5. For other conditions that the evaluator believes could inhibit tank function following an earthquake (e.g. a history of problems with this vessel), assign a risk level relative to the existing levels in the table. Add a descriptive statement for the concern.

A VIII.13 Anchored Vertical Tanks

S.N.	Description	Moderate Earthquake			Severe Earthquake		
		Location in the Building			Location in the Building		
		Bottom Third	Middle Third	Top Third	Bottom Third	Middle Third	Top Third
	<i>Basic Risk</i>	<i>Low</i>	<i>Moderate</i>	<i>Moderate</i>	<i>Moderate</i>	<i>Moderate</i>	<i>High</i>
1	The anchorage is in poor condition	High	High	Very High	High	Very High	Very High
2	Anchor details are non-ductile or could tear the shell	High	High	Very High	High	Very High	Very High
3	Attached piping is too rigid to withstand the expected displacement	Moderate	High	High	High	High	Very High
4	Tank is made of stainless steel	High	High	Very High	High	Very High	Very High
5	Tank is made of fiberglass or similar material	High	Very High	Very High	Very High	Very High	Very High
6	Other _____						
7	Other _____						
8	Other _____						

Choosing Appropriate Risk Level

- 1 Tanks should be anchored and the anchorage should be in good condition (e.g. no heavy corrosion, no significant concrete cracks around the bolts). If not, select 1.
- 2 Poor connection details include anchors clipped to the bottom plate of the tank and chair connections with unusually short chairs. If these or other suspect details exist, select 2.
- 3 Even for anchored tanks, there is a potential for displacement during a seismic event. If the piping attached to the tank is too rigid to survive the expected displacement, select 3. Note that this is more of a concern with rigid piping from the top of an anchored tank.
- 4,5 Select the appropriate risk level if the material used is either stainless steel (likely to be thin walled) or fiber reinforced plastic (fiberglass).
- 6 For other conditions that the evaluator believes could inhibit tank function following an earthquake (e.g. a history of problems with this tank), assign a risk level relative to the existing levels in the table. Add a descriptive statement for the concern.

A VIII.14 Fire Protection Equipment



S.N.	Description	Moderate Earthquake			Severe Earthquake		
		Location in the Building			Location in the Building		
		Bottom Third	Middle Third	Top Third	Bottom Third	Middle Third	Top Third
	<i>Basic Risk</i>	<i>Low</i>	<i>Low</i>	<i>Low</i>	<i>Low</i>	<i>Low</i>	<i>Low</i>
1	There is no regular inspection of the devices to insure proper function	Very High	Very High	Very High	Very High	Very High	Very High
2	Units are not accessible	High	High	Very High	High	Very High	Very High
3	Other _____						
4	Other _____						
5	Other _____						
6	Other _____						

Choosing Appropriate Risk Level

- 1 If there is any question regarding maintenance of the items, select 1.
- 2 If there is any reason to question the ability of the personnel to access the item (location not known, located in a difficult to reach spot, personnel not trained in use, etc.), select 2.
- 3 For other conditions that the evaluator believes could inhibit function following an earthquake, assign appropriate risk level relative to the existing risk in the table. Add a descriptive statement for the concern.

GUIDELINES

for Seismic Vulnerability Assessment of

HOSPITALS

Annex IX: Non-structural Mitigation Options

A IX.1	Removal.....	91
A IX.2	Relocation.....	91
A IX.3	Restricted Mobility for Certain Objects.....	92
A IX.4	Anchorage.....	93
A IX.5	Hooking	95
A IX.6	Strapping	97
A IX.7	Flexible couplings	98
A IX.8	Supports	99
A IX.9	Substitution.....	100
A IX.10	Modification.....	100
A IX.11	Reinforcement.....	100
A IX.12	Redundancy.....	100
A IX.13	Rapid Response and Repair.....	100
A IX.14	Improving Safety of Operation Theatres	101
A IX.15	Development of Chaining System on Beds	102

List of Figures

Figure A-IX. 1:	Increasing Safety of Hospital Personnel by Removing Less Important Things.....	91
Figure A-IX. 2:	Life Safety Hazard Near Exit.....	92
Figure A-IX. 3:	Securing Equipment which needs a Certain Level of Vibration.	93
Figure A-IX. 4:	Fixing of Autoclave.....	94
Figure A-IX. 5:	Anchoring Water Tanks to the Floor.....	94
Figure A-IX. 6:	Anchoring Cupboards and Fridges to the Wall.....	95
Figure A-IX. 7:	Securing ECG Machines on Rollers by Hooking to the Wall.....	96
Figure A-IX. 8:	Securing Mobile X-Ray Machine on Rollers by Hooking to the Wall.....	96
Figure A-IX. 9:	Securing Resuscitation Equipment on Roller Trolley by Strapping and Hooking.	97
Figure A-IX. 10:	Increasing Safety of Oxygen Gas Cylinders.....	97
Figure A-IX. 11:	Increasing Safety of Chemical and Medicine Bottles on Shelves using Nylon Rope.....	98
Figure A-IX. 12:	Flexible Pipe Connection with Heavy Equipment.....	99
Figure A-IX. 13:	Securing Ceiling Fans.....	99
Figure A-IX. 14:	Securing Window Panels by Plastic Lamination.	100
Figure A-IX. 15:	Increasing Safety of Operation Theatres.....	101
Figure A-IX. 16:	Development of a Chaining System on Beds in Critical Wards and Departments of the Hospital.....	102

Annex IX: Non-structural Mitigation Options

The appropriate risk mitigation option might be different for all individual components and must be identified and recommended during the study. The availability of local material and technology shall be considered during recommendation of mitigation options. Some of the possible mitigation measures identified in the study *Non-structural Vulnerability Assessment of Hospitals in Nepal* are given in this Annex as a reference. The cost given is the cost required for locally available materials and manpower.

A IX.1 Removal

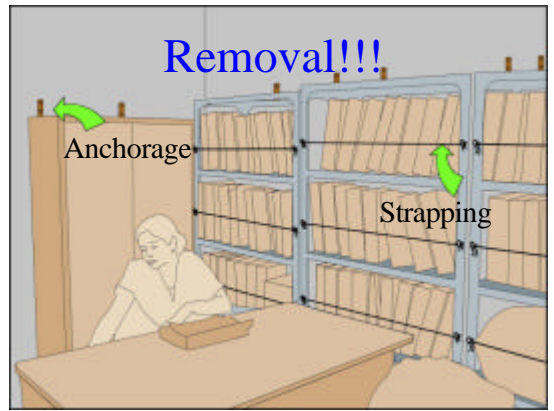

Removal is probably the best mitigation option in many cases. Less important or non-essential documents and materials stored near the working place or near important equipment can easily be removed to achieve a safer situation. Another solution for such cases would be better fastenings or the use of stronger supports, but the most effective solution would be removal and replacement.

	
<p>These document packs stored on the top of book shelves and cupboards are a life safety hazard.</p>	<p>Life safety hazards can be reduced just by removing less important things from the working place.</p>
<p><i>Figure A-IX. 1: Increasing Safety of Hospital Personnel by Removing Less Important Things.</i></p>	
<p>Approximate Cost: Cost depends on the type of things to be removed.</p>	

A IX.2 Relocation

Relocation would reduce the danger in many cases. For example, a very heavy object on top of a shelf could fall and seriously injure someone as well as break thereby causing economic losses. But by relocating heavy equipment and materials from upper shelves to lower shelves the risk could be mitigated. This is the case in most hospitals where the functionality of the operation theatre stores could be improved by doing so.

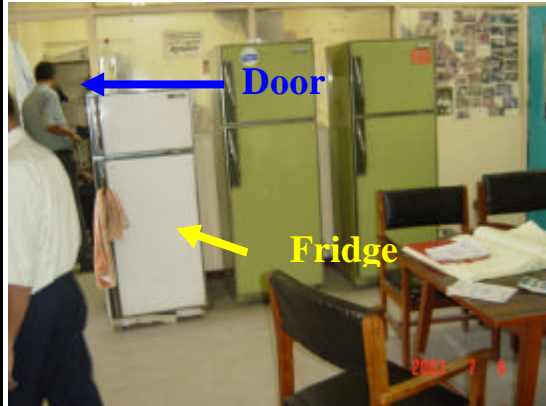
Cupboards and book shelves kept near an exit door or passage, which can obstruct the way and cause human death or injury during an earthquake event, are typical examples found in many hospitals. These book shelves and cupboards could easily be relocated to other places where the potential dangers would be reduced.

 <p>The fridge kept near an exit door is a life safety hazard.</p>	 <p>These cupboards can block the corridor and pose a life safety hazard.</p>
<p><i>Figure A-IX. 2: Life Safety Hazard Near Exit.</i></p>	
<p>Approximate cost for relocation = US\$ 1 per item. <i>Note: The space required for relocating components play a vital role in this case.</i></p>	

A IX.3 Restricted Mobility for Certain Objects

Restricted mobility for certain objects such as gas cylinders and power generators is a good measure. It does not matter if the cylinders shift as long as they do not fall and break their valves. Sometimes back-up power generators are mounted on springs to reduce the noise and vibrations when they are working, but these springs would amplify ground motion. Therefore, restraining supports or chains should be placed around the springs to keep the generator from shifting or being knocked off its stand.

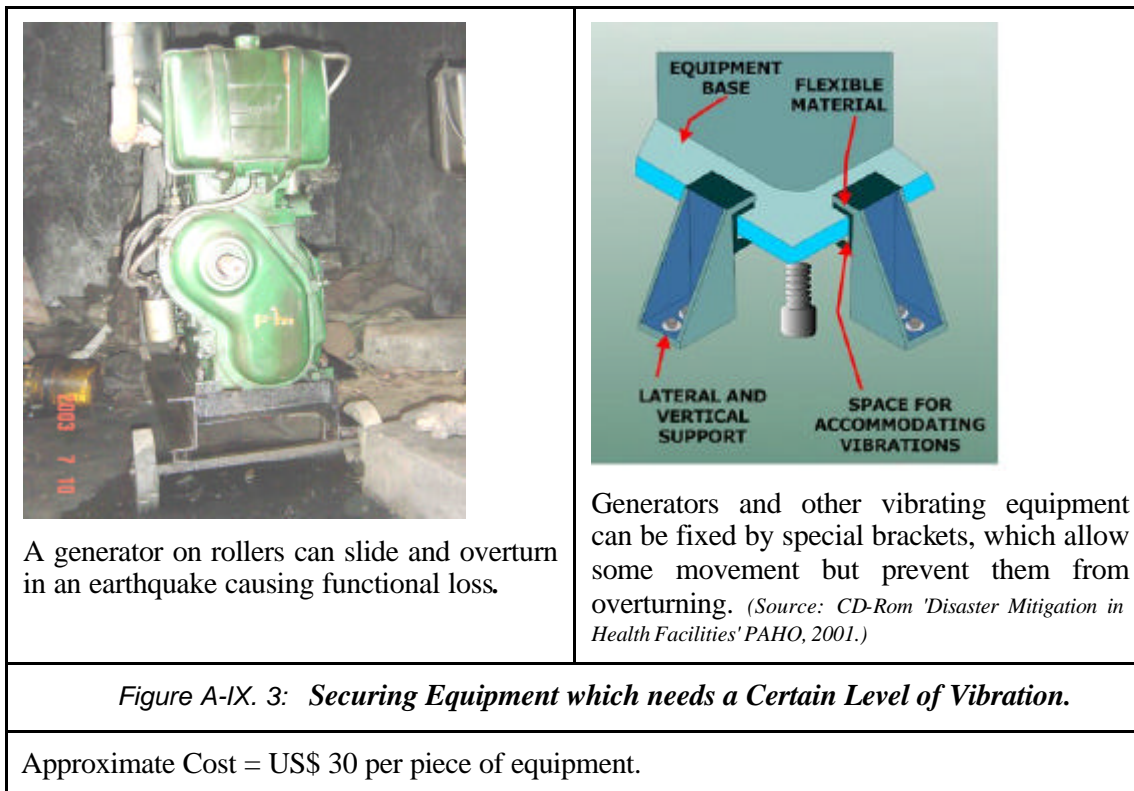

A IX.4 Anchorage

Anchorage is the most widely used precaution. It is a good idea to use bolts, cables or other materials to prevent valuable or large components from falling or sliding. The heavier the object, the more likely it is that it will move due to the forces produced by an earthquake. Autoclave machines in all hospitals are a good example. They are heavy and can easily fall and break. The simple solution is to anchor the feet of the machines to the concrete floor.

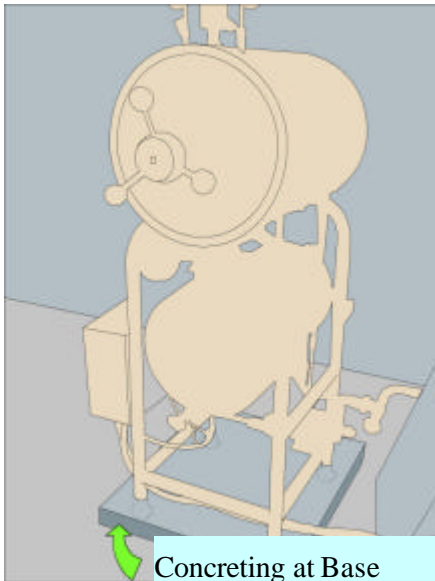
 <p>Autoclave machine without anchorage.</p>	 <p>Concreting at Base</p> <p>This machine can be fixed to the floor by casting a concrete base.</p>
<p><i>Figure A-IX. 4: Fixing of Autoclave.</i></p>	
<p>Approximate Cost = US\$ 10 per piece of equipment.</p>	

Some equipment and components of a system can easily be bolted to the floor. Transformers, water treatment tanks, communication equipment and control panels of X-ray units are typical examples of equipment that can be anchored to the floor.

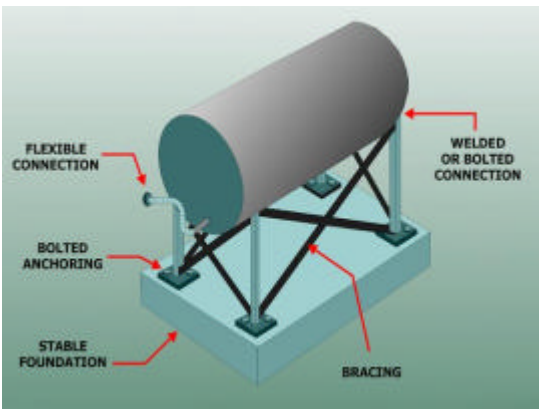
 <p>Water treatment tank, which has a provision for bolting at the base, but is not bolted.</p>	 <p>Bolting at the base can prevent overturning of heavy objects during an earthquake. (Source: CD-Rom 'Disaster Mitigation in Health Facilities' PAHO, 2001.)</p>
<p><i>Figure A-IX. 5: Anchoring Water Tanks to the Floor.</i></p>	
<p>Approximate Cost = US\$ 20 per piece of equipment.</p>	

In most medical facilities and administration sections, cupboards, fridges and racks storing medical equipment, books, documents or chemicals pose life safety hazards as well as functional and / or property losses. This can easily be prevented by anchoring them to the wall using angles and nails as this will stop them from overturning.

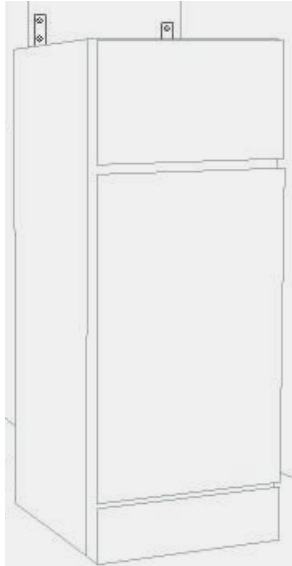
 <p>Tall and narrow objects like fridges can easily overturn during earthquakes.</p>	 <p>Such objects can be protected from overturning by bolting them to the wall.</p>
<p><i>Figure A-IX. 6: Anchoring Cupboards and Fridges to the Wall.</i></p>	
<p>Approximate Cost = US\$ 5 per item.</p>	

A IX.5 Hooking

In many hospitals, much equipment like ECG monitors, suction units, ventilators, incubators, B.P. monitors, resuscitation equipment, etc. is kept on rollers or roller trolleys, and the roller systems are necessary for better mobility. But this equipment on rollers can slide and impact with people, the walls, beds or other things causing impact hazard to the other object or person and damage to the piece of equipment itself.

Development of a proper hooking system using chains and hooks can protect this equipment and can decrease the impact hazard during use and storage respectively. Provision of a hooking system on beds could be one way of hooking equipment at the time of use. At the time of storage, the equipment can be hooked to the wall by chains.



ECG monitors on rollers with potential risk of sliding and overturning.

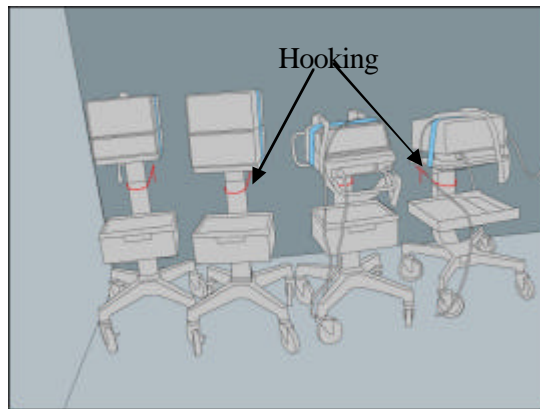

Provision of chains on the wall to hook such machines.

Figure A-IX. 7: Securing ECG Machines on Rollers by Hooking to the Wall.

Approximate Cost: US\$ 10 per piece of equipment.



Mobile X-ray on rollers.

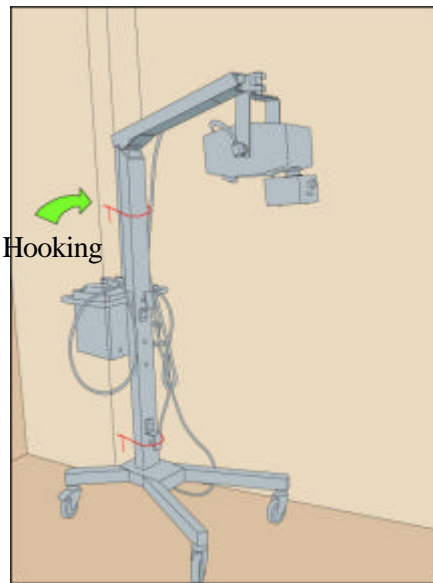

Hooking of mobile X-ray to the wall.

Figure A-IX. 8: Securing Mobile X-Ray Machine on Rollers by Hooking to the Wall.

Approximate Cost: US\$ 10 per piece of equipment.

Some equipment on roller trolleys can also be protected from falling by strapping the equipment to the trolley and hooking the trolley to the wall. Slender objects like oxygen cylinders can also be hooked using chains.

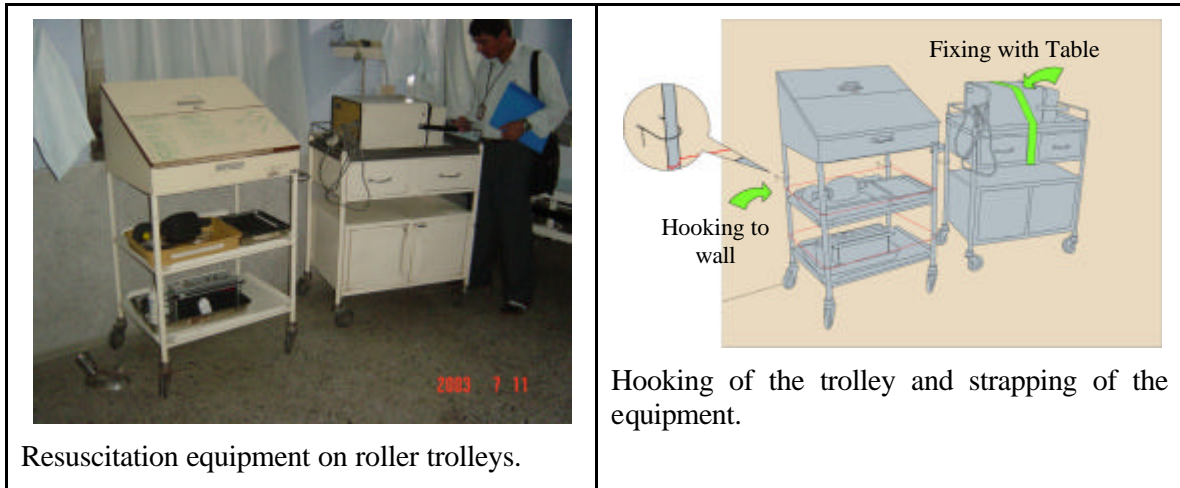

Figure A-IX. 9: Securing Resuscitation Equipment on Roller Trolley by Strapping and Hooking.

Approximate Cost: US\$ 10 per piece of equipment.

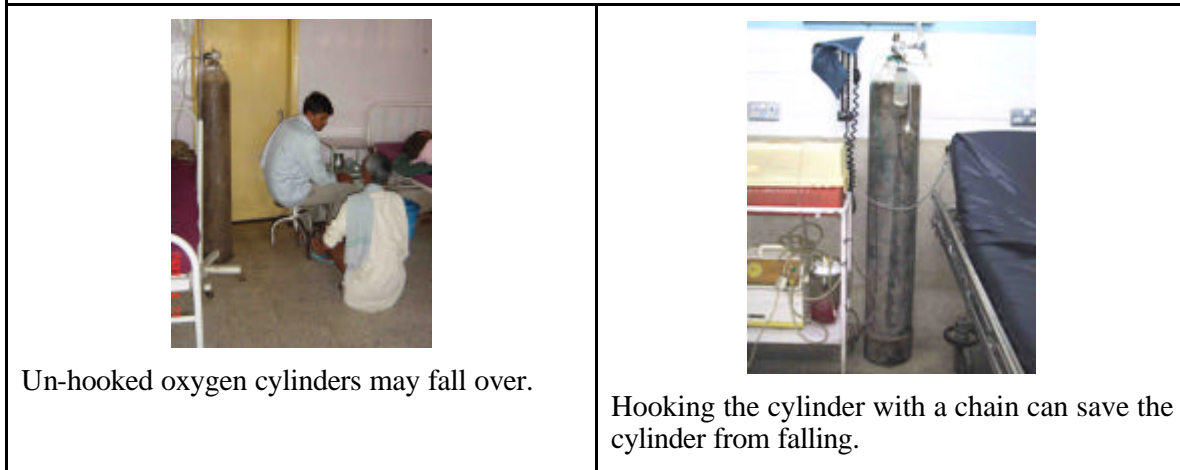

Figure A-IX. 10: Increasing Safety of Oxygen Gas Cylinders.

Approximate Cost: US\$ 10 per piece of equipment.

A IX.6 Strapping

In many hospitals, the supplies and contents of laboratories, medical stores, general stores, CSSD stores and OT stores are kept unsecured on shelves and in racks and would, consequently, fall down and brake during earthquakes. To mitigate this risk is not difficult; once the racks and cupboards have been anchored to the wall, the contents can easily be secured by using strapping, thus preventing chemical bottles and medicine stored on the shelves from falling down.



Chemical and medicine bottles on shelves pose a risk of falling.

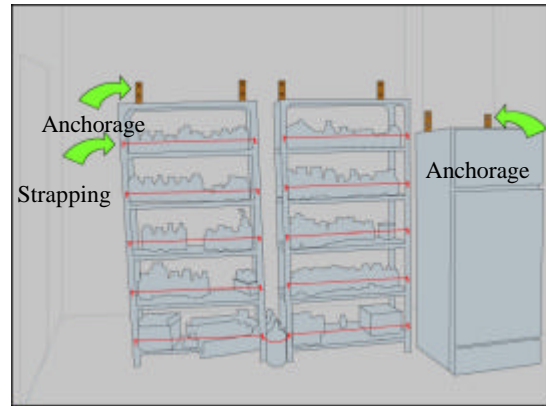

Strapping the shelves by nylon rope after anchoring the rack to the wall is an easy way of making these bottles safe.

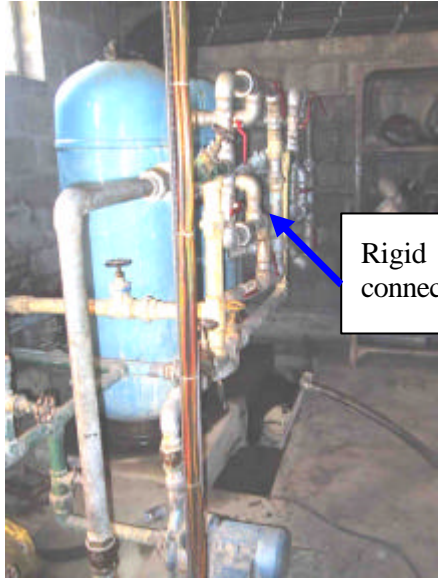

Figure A-IX. 11: Increasing Safety of Chemical and Medicine Bottles on Shelves using Nylon Rope.

Approximate Cost: US\$ 10 per rack / cupboard.

A IX.7 Flexible couplings

If there is a tank outside the building with a rigid connection pipe joining the building and the tank together, the tank will vibrate at frequencies, in directions and at amplitudes different to those of the building, which will cause the pipe to break. A flexible pipe between the two parts would prevent ruptures of this kind. Flexible couplings are necessary because separate objects each move independently in response to an earthquake; some move quickly, others slowly.

Consequently, flexible piping is necessary near heavy equipment, at the joint of two buildings and in seismic joints of the same building.

 <p>Rigid pipe connection.</p> <p>Rigid pipes connected with a heavy water tank can break during an earthquake.</p>	 <p>Flexible pipe connected with heavy equipment.</p> <p>Flexible piping on heavy equipment protects it from breaking during an earthquake.</p>
<p><i>Figure A-IX. 12: Flexible Pipe Connection with Heavy Equipment.</i></p>	
<p>Approximate Cost: US\$ 100-200 per piece of equipment.</p>	

A IX.8 Supports

Supports are suitable in many cases. For example, ceilings are usually hung from cables that only withstand the force of gravity. When subjected to the horizontal stresses and torsion of an earthquake, they easily fall. They can cause serious injury to people underneath them and obstruct evacuation routes. Extra support by additional wires can protect the ceiling or light fixtures from falling.

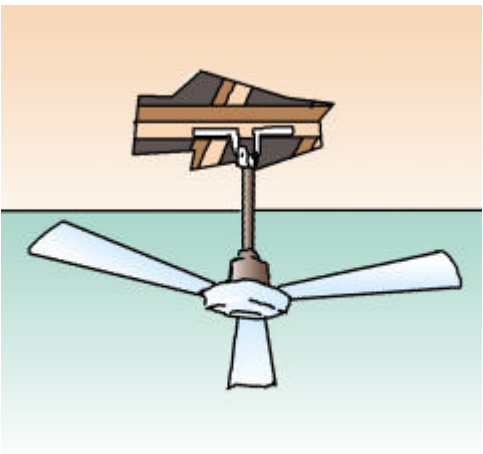
 <p>This type of fan needs extra support.</p>	 <p>Extra support to the fan.</p>
<p><i>Figure A-IX. 13: Securing Ceiling Fans.</i></p>	
<p>Approximate Cost: US\$ 10 per item.</p>	

A IX.9 Substitution

Substitution with something that does not represent a seismic hazard is appropriate in some situations. For example, a heavy, tiled roof does not only make the roof of a building heavy, it is also more susceptible to the movement of an earthquake. The individual tiles tend to come off, thus creating a hazard for people and objects. One solution would be to change it with a lighter, safer roofing material.

A IX.10 Modification

Modification is a possible solution for an object that represents a seismic hazard. For example, earth movements twist and distort a building possibly causing the rigid glass in the windows to shatter and launch sharp glass splinters onto the occupants and the passers-by around the hospital. Rolls of transparent adhesive plastic may be used to cover the inside surfaces and prevent them from shattering and threatening those inside. The plastic is invisible and reduces the likelihood of a glass window causing injuries.

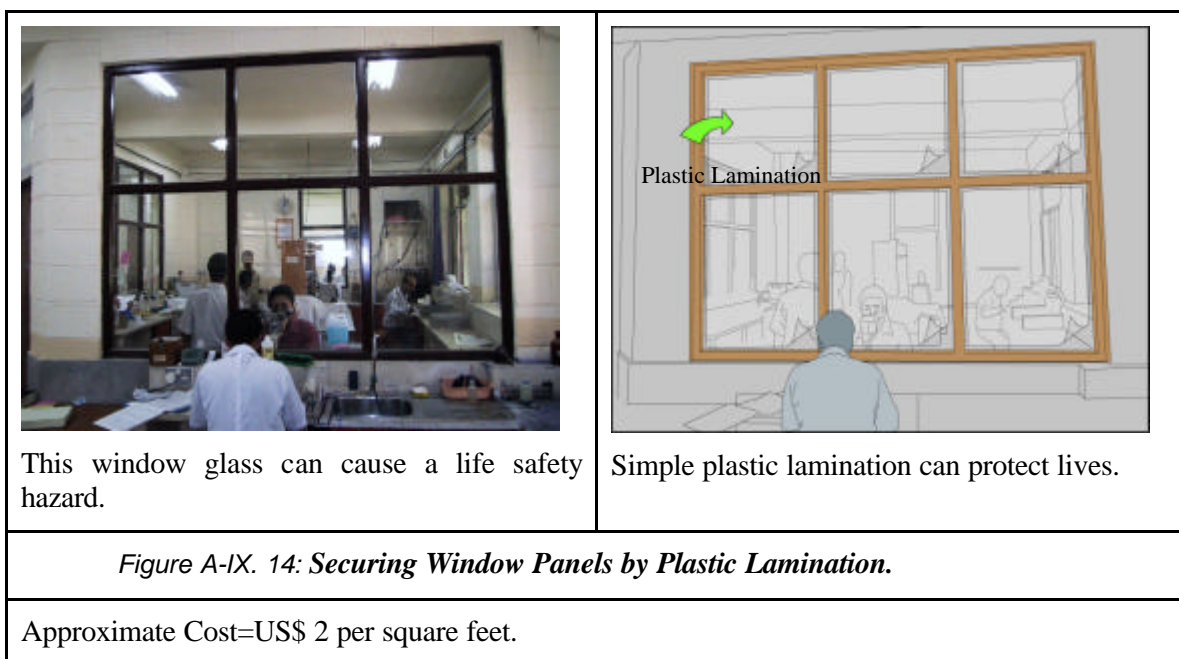

A IX.11 Reinforcement

Reinforcement is feasible in many cases. For example, an un-reinforced infill wall or a chimney may be strengthened without great expense by covering the surface with wire mesh and cementing it.

A IX.12 Redundancy

Redundancy or duplication of items is advisable. Emergency response plans that call for additional supplies are a good idea. It is possible to store extra amounts of certain products providing a certain level of independence from external supplies that could be interrupted in case of an earthquake.

A IX.13 Rapid Response and Repair

Rapid response and repair is a mitigation measure used on large oil pipelines. Sometimes it is not possible to do anything to prevent the rupture of a pipeline in a given place. Therefore, spare parts are stored nearby and arrangements are made to enter the area quickly in case a pipe breaks during an earthquake. Similarly, a hospital should have spare plumbing, emergency power supplies and other necessary components at hand together with the suitable tools in order to ensure that repairs can be easily made if something is damaged. For example,

during an earthquake the water pipes may break; it may be impossible to take prior measures to totally eliminate this risk, but it is possible to ensure that everything necessary for quick repairs is at hand. With prior earthquake planning it is possible to save the enormous costs of water damage with a minimum investment in a few articles. These general measures are applicable to almost all situations. However, in many cases, it is enough to be creative and to devise one's own way of mitigating the effects of disasters.

A IX.14 Improving Safety of Operation Theatres

Most of equipment in operation theatres is kept on rollers or roller trolleys without any fixity and may therefore be highly vulnerable. However, for everyday use this equipment must be flexible and mobile and cannot be permanently fixed. Thus, a special system for anchoring the equipment is necessary; anchoring which can fix the equipment during operations and can be removed afterwards.

The system can be a steel frame consisting of vertical and horizontal angles attached to the equipment rack. The system should have a number of chains, straps, hooks and guide bars in the rack for fixing and securely placing the equipment in the rack. The frame can then be fastened in a location near the operation table during the operation. By providing anchor bolts in the ceiling and in the floor of the room, the equipment rack can be placed in position near the OT table. Similarly, anchor bolts should be provided in the walls in appropriate locations so that the equipment can be removed and fixed in a safe place when not used.



Most equipment is on roller trolleys (equipment racks) in operation theatres. The risk of falling down is high.

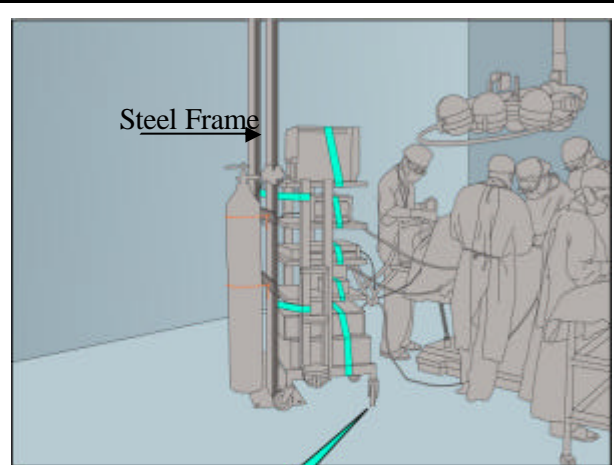

Tying all equipment to a steel frame can improve the situation.

Figure A-IX. 15: Increasing Safety of Operation Theatres

Approximate Cost=US\$ 500-1000 per operation theatre; it depends on the number of pieces of equipment in the operation theater.

A IX.15 Development of Chaining System on Beds

The equipment and the accessories needed for treatment are generally placed near the beds in important wards like ICU, CCU, post operative, and maternity wards but without any anchor or support in general. This equipment and accessories should be fixed to reduce the vulnerability and enhance the hospital performance after an earthquake. Providing chains and anchor hooks on each bed could solve the problem.

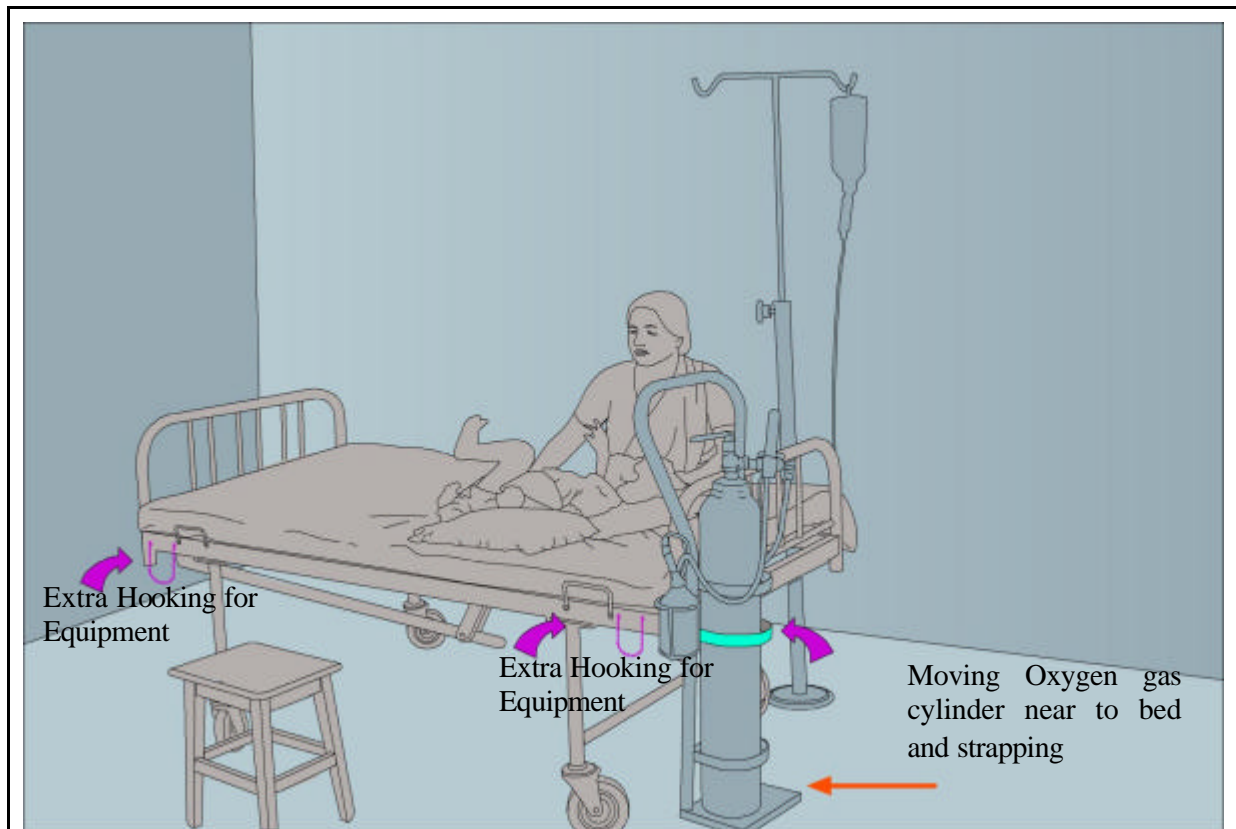

Figure A-IX. 16: *Development of a Chaining System on Beds in Critical Wards and Departments of the Hospital.*

Approximate cost = US\$ 30 per bed.

GUIDELINES
for Seismic Vulnerability Assessment of
HOSPITALS

Annex X: Sample of Non-structural Components Evaluation Sheets

Annex X: Sample of Non-structural Components Evaluation Sheets

Table 1: Non-structural Component Evaluation (Water Supply System)

S.N.	Non-structural Element	Quantity	Earthquake	Risk Rating	Type of Risk	Location	Linked Equipments	Mitigation Options	Implementation Priority	Estimated Cost for Implementing Mitigation Option (US\$)	Remarks
1	Filtration Tanks	3	Moderate	VH	LF	First Filtration room	Electricity, Motors	Proper Anchorage to Floor	First	60.00	Tanks are just supported by connected pipes
			Severe	VH							
2	Pipe joints Connected with tanks	10	Moderate	M	LF	First Filtration room		Installation of Flexible Coupling	Second	1,000.00	Pipes are rigidly connected with tanks
			Severe	H							
3	Rack storing old and new motors	1	Moderate	VH	LS, Block the way to motors and tanks	First Filtration room		Anchorage to Wall	First	10.00	
			Severe	VH							
4	Filtration Tanks	2	Moderate	H	LF	Second Filtration Room	Electricity, Motors	Anchorage to Floor	First	40.00	There is provision to anchorage but not anchored due to lack of knowledge on maintenance staff
			Severe	H							
5	Pumps	12	Moderate	M	LF	At different Places	Electricity, Pipes	Anchorage to Floor	Second	240.00	Poorly Anchored
			Severe	H							
6	Pipe joints	20	Moderate		LF	At different Places		Installation of Flexible Coupling	Second	2,000.00	All pipeline system is rigidly connected
			Severe								

Table 2: Non-structural Component Evaluation (Medical Facilities-1)

S.N.	Non-structural Element	Quantity	Earthquake	Risk Rating	Type of Risk	Location	Linked Equipments	Mitigation Options	Implementation Priority	Estimated Cost for Implementing Mitigation Option (US\$)	Remarks
1	Washing Machines	4	Moderate	M	LF	Laundry Room	-	Anchorage	Second	40.00	On large base less chance of toppling
			Severe	H							
2	Squishing Machine	1	Moderate	L	LF	Laundry Room	-	-	-	-	Properly anchored
			Severe	L							
3	Drier Machines	3	Moderate	M	LF	Laundry Room	-	Anchorage	Second	30.00	On large Base
			Severe	H							
4	Cupboard	1	Moderate	VH	LS	Laundry Office	-	Anchorage	First	5.00	Near Working Table
			Severe	VH							
5	Cupboard and Racks	7	Moderate	VH	LS	Laundry Store	-	Anchorage and Relocation	First	35.00	Boxes from top of cupboards need relocation
			Severe	VH							
6	Boilers	2	Moderate	VH	PL	Kitchen	-	Anchorage	Second	20.00	
			Severe	VH							
7	Racks	4	Moderate	VH	LS	Kitchen	-	Anchorage	First	20.00	
			Severe	VH							
8	Fridge	1	Moderate	VH	LS	Dieting Section Office	-	Anchorage	First	5.00	Near Working Table
			Severe	VH							
9	Book Shelves	15	Moderate	VH	LS	Medical Library	-	Anchorage	First	75.00	
			Severe	VH							
10	Autoclave Machines	3	Moderate	VH	LF	CSSD	-	Fixing	First	30.00	
			Severe	VH							
11	Racks	20	Moderate	VH	LS	CSSD	-	Anchorage/Relocation	First	100.00	Relocation of boxes containing sterile equipments from top of the racks are recommended to relocate
			Severe	VH							
12	Trolley	15	Moderate	VH	LF	CSSD	-	Hooking	First	150.00	All are on roller
			Severe	VH							
13	Racks	2	Moderate	VH	LS	Administration	-	Anchorage/Relocate	First	10.00	Relocate the rack near exit
			Severe	VH							
14	Racks	2	Moderate	VH	LS	In Service Education	-	Anchorage	First	10.00	
			Severe	VH							
15	Cupboards and Racks	5	Moderate	VH	LS	Nursing Director	-	Anchorage	First	25.00	One cupboard and four racks
			Severe	VH							

GUIDELINES

for Seismic Vulnerability Assessment of

HOSPITALS

Annex XI: Building Performance Levels

A XI.1	Operational Occupancy Building Performance Level.....	110
A XI.2	Immediate Occupancy Building Performance Level.....	110
A XI.3	Life Safety Building Performance Level.....	110
A XI.4	Collapse Prevention Building Performance Level.....	110

List of Figure

Figure A-XI. 1: Illustration of Building Performance Levels	109
--	------------

Annex XI: Building Performance Levels

The performance level describes a damage condition, which may be considered satisfactory for a given building and a given ground motion. The condition is described by the physical damage within the building, the threat to life safety of the building occupants created by the damage, and the post-earthquake serviceability of the building. A combination of the structural performance level and the nonstructural performance level forms the building performance level.

$$\begin{aligned} \text{Building Performance Level} = \\ \text{Structural Performance Level} \\ + \\ \text{Non-structural Performance Level} \end{aligned}$$

Four building performance levels used for this guideline based on “*Prestandard and Commentary for the Seismic Rehabilitation of Buildings*”, FEMA 356 is described in this Annex.

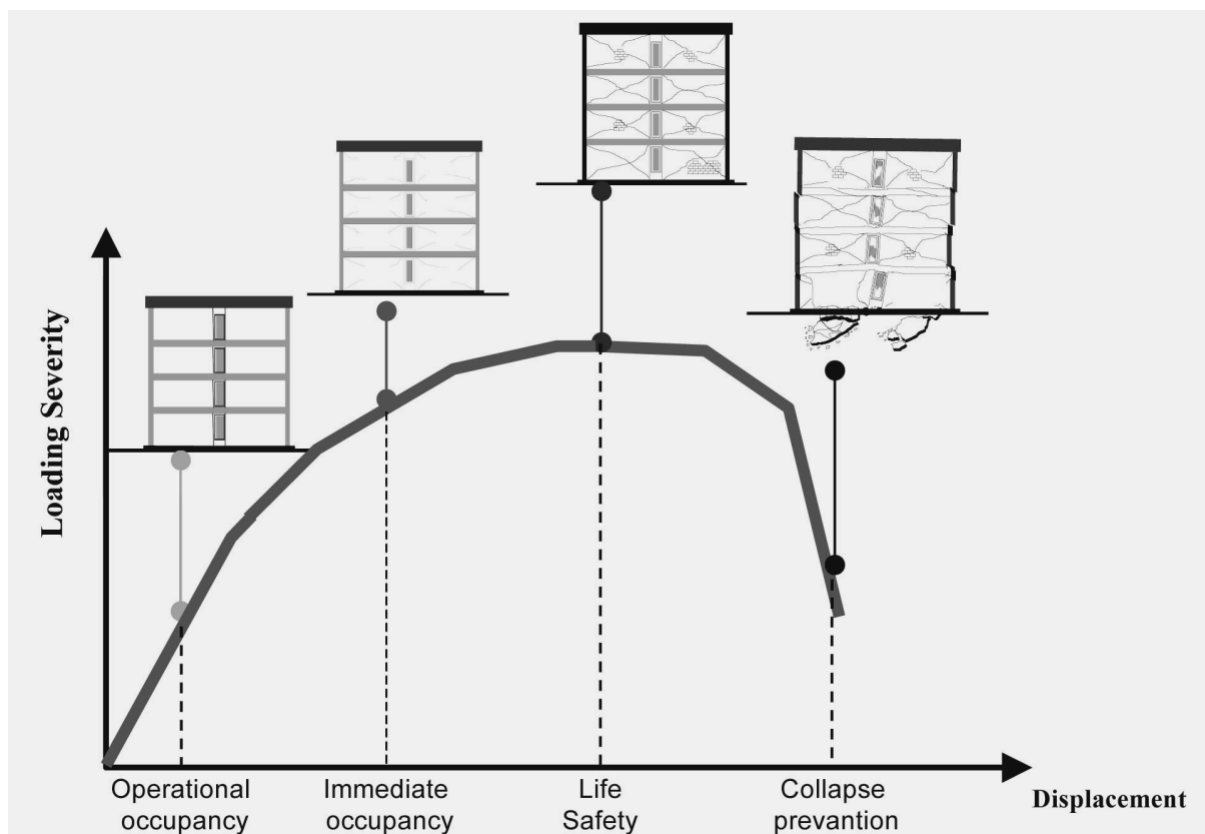

Figure A-XI. 1: *Illustration of Building Performance Levels*

A XI.1 Operational Occupancy Building Performance Level

Buildings meeting this target building performance level are expected to sustain minimal or no damage to their structural and non-structural components. The building is suitable for its normal occupancy and use, although possibly in a slightly impaired mode with power, water and other required utilities provided from emergency resources, and possibly with some non-essential systems not functioning. Buildings meeting this target building performance level pose an extremely low risk to life safety.

A XI.2 Immediate Occupancy Building Performance Level

Buildings meeting this target building performance level are expected to sustain minimal or no damage to their structural elements and only minor damage to their non-structural components. While it would be safe to reoccupy a building meeting this target building performance level immediately following a major earthquake, non-structural systems may not function either because of the lack of electrical power or internal damage to equipment. Therefore, although immediate re-occupancy of the building is possible, it may be necessary to perform some cleanup and repair activities and await the restoration of utility services before the building can function in a normal mode. The risk to life safety at this target building performance level is very low.

A XI.3 Life Safety Building Performance Level

Buildings meeting this level may experience extensive damage to structural and non-structural components. Repairs may be required before re-occupancy of the building occurs, however, repair may be deemed economically impractical. The risk to life safety in buildings meeting this target building performance level is low.

A XI.4 Collapse Prevention Building Performance Level

Buildings meeting this target building performance level may pose a significant hazard to life safety resulting from failure of non-structural components. However, because the building itself does not collapse, gross loss of life may be avoided. Many buildings meeting this level will pose a complete economic loss.

GUIDELINES

for Seismic Vulnerability Assessment of

HOSPITALS

Annex XII: Modified Mercalli Intensity Scale (MMI Scale)

Annex XII: Modified Mercalli Intensity Scale (MMI Scale)

The Modified Mercalli Intensity scale is designed to describe the effects of an earthquake; at a given place, on natural features, on industrial installations and on human beings. The intensity scale differs from magnitude, which is related to the energy released by an earthquake. There are multiple versions of the MMI scale, the one listed here being the 1931 version. Figures have been prepared based on the description of effects in each intensity scale.

MMI I



Not felt - except rarely under especially favorable circumstances. Under certain conditions, at and outside the boundary of the area where the shock started: sometimes birds and animals are reported being uneasy or disturbed; sometimes dizziness or nausea can be experienced; sometimes trees, structures, liquid and bodies of water, may sway - doors may swing very slowly.

MMI II



Felt indoors by a few people, especially on upper floors, or by sensitive or nervous persons. Also, as in grade I but more noticeably: sometimes hanging objects may swing especially when delicately suspended; sometimes trees, structures, liquids and bodies of water may sway, doors may swing very slowly; sometimes birds and animals are reported being uneasy or disturbed; sometimes dizziness or nausea can be experienced.

MMI III



Felt indoors by several people. The motion will usually be felt as a rapid vibration. Sometimes, it will not be recognized as an earthquake at first, but in some cases the duration of the earthquake can be estimated. Vibration like that could be due to light, or lightly loaded trucks passing or heavy trucks some distance away. Hanging objects may swing slightly. Movement may be appreciable on upper levels of tall structures. Standing motor cars will rock slightly.

MMI IV



Felt indoors by many people, outdoors by few. A few people will be woken up, especially light sleepers. No one will be frightened unless they are apprehensive from a previous experience. Vibration like that could be due to passing of heavy, or heavily loaded trucks. The sensation is like a heavy body striking the building or heavy objects falling inside. Dishes, windows, doors; glassware will rattle and crockery clink and clash. Walls and the frame will creak, especially in the upper range of this grade. In numerous instances, hanging objects have been known to swing. Liquids in open vessels will be slightly disturbed. Standing motor cars will rock slightly.

MMI V

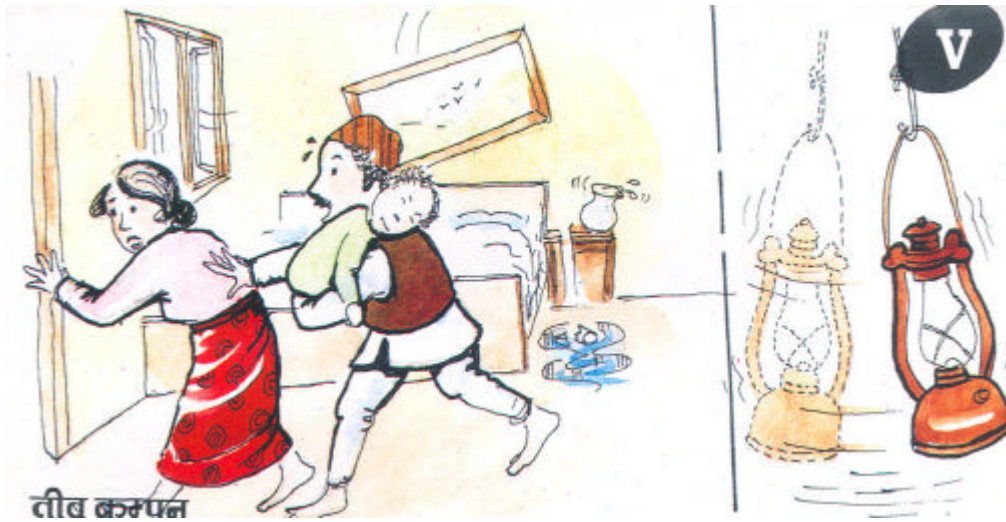

Felt indoors by practically all, outdoors by many or most. People outdoors can estimate from which direction the earthquake comes. Many or most people will wake up. A few will be frightened – there will be slight excitement and a few people may run outdoors. Buildings tremble throughout. Dishes and glassware will break to some extent. In some cases, windows may crack - but not generally. Small or unstable objects will overturn in many instances and occasionally fall. Hanging objects and doors swing. Pictures will knock against walls or will swing out of place. Doors and shutters may open or close abruptly. Pendulum clocks may stop, start, run fast or slow. Small objects and furnishings will move, the latter to a slight extent. Open containers completely filled with liquid will spill over. Trees and bushes are shaken slightly.

MMI VI



Felt by all, indoors and outdoors. Many people will be frightened. There will be general excitement and some alarm and many will run outdoors. Everybody will be awakened. People will be made to move unsteadily. Trees and bushes will be slightly to moderately shaken. Liquid will be set in strong motion. Small bells will ring -church, chapel, school etc. There will be slight damage to poorly built buildings. Small amounts of plaster will fall and generally crack somewhat, especially, there will be fine cracks in chimneys in some instances.

Dishes and glassware in considerable quantity will break, including some windows. Knick-knacks, books and pictures will fall. In many instances furniture will overturn. Furnishings of moderately heavy kind will move.

MMI VII



Frightens everybody - general alarm and people will run outdoors. Some, or many, will find it difficult to stand. It will be noticed by persons driving motor cars. Trees and bushes are shaken moderately to strongly. There will be waves on ponds, lakes and running water. Water will be turbid from mud stirred up. There will be in-caving to some extent of sand or gravel stream banks. Large church bells, etc will ring. Suspended objects are made to quiver. Damage negligible in buildings of good design and construction, slight to moderate in well-build ordinary buildings, considerable in poorly build or badly designed buildings, abode houses, old walls (especially where laid up without mortar), spires, etc. There will be a considerable extent of cracked chimneys and some extent of cracking in walls. Plaster will fall in considerable to large amounts and some stucco as well. Numerous windows will break and furniture to some extent. Loosened brickwork and tiles will be shaken down. Weak chimneys will break at the roof-line (sometimes damaging the roof). Cornices from towers and high buildings will fall and bricks and stones will dislodge. Heavy furniture will overturn and break. There will be considerable damage to concrete irrigation ditches.

MMI VIII

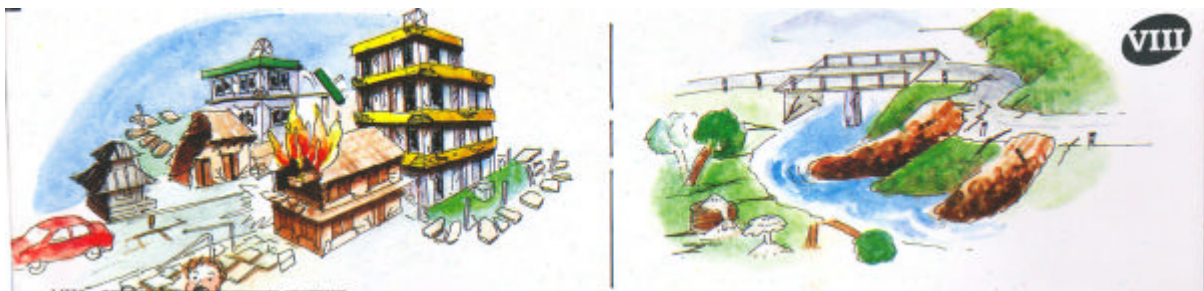

Fright general - the alarm approaches panic. People driving motor cars can feel the motion.. Trees are shaken strongly – branches and trunks will be broken off, especially palm trees. Small amounts of sand and mud will be ejected. There will be both temporary and permanent changes in the flow of springs and wells; dry wells may experience renewed flow and there may be a change in the temperature of spring and well water. Damage will be slight in structures (brick) built especially to withstand earthquakes. It will be considerable in ordinary substantial buildings and there will be partial collapse: In some cases, the shape of wooden housed will twist and contort, frame structures may throw out panel walls and decayed piling will break off. Walls will fall. Solid stone walls will seriously crack and break. There will be some extent of landslides in wet ground and on steep slopes. Chimneys, columns, monuments, factory stacks and towers will twist and fall. Very heavy furniture will move conspicuously and overturn.

MMI IX



General panic and conspicuously cracked ground. Considerable damage in (masonry) structures build especially to withstand earthquakes: some wood-frame houses build especially to withstand earthquakes will throw out of plumb; great cracks will occur in most (masonry) buildings, some masonry buildings will collapse; or frame buildings will wholly shift off foundations, frames will be racked; serious damage to reservoirs; underground pipes will sometimes break.

MMI X



Cracked ground, especially if it is loose and wet, up to widths of several inches; fissures up to a yard in width running parallel to canals and stream banks. Considerable landslides from river banks and steep coasts. Sand and mud will shift horizontally on beaches and flat land. The water level in wells will change. Water is thrown on the banks of canals, lakes, rivers, etc. Serious damage to dams, dikes and embankments. Severe damage to well-built wooden structures and bridges and some will be destroyed. Dangerous cracks in excellent brick walls will develop. Most masonry and frame structures, including their foundations will be destroyed. Railroad rails will bend slightly. Pipe lines buried in the earth will tear apart, or crushed in many places. There will be open cracks and broad wavy folds in cement pavements and asphalt road surfaces.

MMI XI



Disturbances in the ground will be many and widespread, varying with the ground material. Broad fissures, earth slumps and land slips will happen in soft, wet ground. Large amounts of water charged with sand and mud will be ejected. It will cause sea-waves ("tidal" waves) of significant magnitude. There will be severe damage to wood-frame structures, especially near shock centers. Great damage to dams, dikes and embankments, often far removed from the shock center. Few, if any (masonry), structures remain standing. Large well-built bridges will be destroyed by the wrecking of supporting piers or pillars. Railroad rails will bend and be thrust out of place. Pipe lines buried in the earth will be completely out of service.

MMI XII



Damage is total - practically all construction works will be greatly damaged or destroyed. Disturbances in the ground are great and varied with numerous shearing cracks. Landslides, significant falling of rocks, slumping of river banks, etc. are numerous and extensive. Large rock masses will be wrenched loose and torn off. There will be fault slips in firm rock with notable horizontal and vertical offset displacements. Water channels, both surface and underground, will be disturbed and modified greatly. Dammed lakes will produce waterfalls and river will be deflected, etc. Waves can be seen on ground surfaces. Levels as well as lines of sight will be distorted. Objects are thrown upward into the air.

GUIDELINES

for Seismic Vulnerability Assessment of

HOSPITALS

Annex XIII: Checklist for Assessment of Architectural Non-Structural Components

A XIII.1	Partition Wall	121
A XIII.2	Parapets.....	121
A XIII.3	Window Panels	121
A XIII.4	False Ceiling	121
A XIII.5	Cladding System.....	122

Annex XIII: Checklist for Assessment of Architectural Non-Structural Components

A XIII.1 Partition Wall

- C NC N/A UNREINFORCED MASONRY: Un-reinforced masonry or hollow clay tile partitions shall be braced at a spacing of equal to or less than 6 feet.
- C NC N/A DRIFT: The drift ratio for masonry partitions shall be limited to 0.005.
- C NC N/A STRUCTURAL SEPARATIONS: Partitions at structural separations shall have seismic or control joints.
- C NC N/A TOPS: The tops of framed or panelized partitions that only extend to the ceiling line shall have lateral bracing to the building structure at a spacing of equal to or less than 6 feet.

A XIII.2 Parapets

- C NC N/A UNREINFORCED MASONRY PARAPETS: There shall be no laterally unsupported un-reinforced masonry parapets or cornices above the highest anchorage level with height-to-thickness ratios greater than 1.5.
- C NC N/A CONCRETE PARAPETS: Concrete parapets with height-to-thickness ratios greater than 2.5 shall have vertical reinforcement.

A XIII.3 Window Panels

- C NC N/A GLASS PANELS: There shall be no window glass panels without plastic lamination.

A XIII.4 False Ceiling

- C NC N/A INTEGRATED CEILINGS: Integrated suspended ceilings at exits and corridors or weighing more than 2 lb/ft² shall be laterally restrained with a minimum of 4 diagonal wires or rigid members attached to the structure above at a spacing of equal to or less than 12 ft.
- C NC N/A LAY-IN TILES: Lay-in tiles used in ceiling panels located at exit ways and corridors shall be secured with clips.
- C NC N/A SUPPORT: The integrated suspended ceiling system shall not be used to laterally support the tops of gypsum boards, masonry, or hollow clay tile partitions.
- C NC N/A SUSPENDED LATH AND PLASTER: Ceilings consisting of suspended lath and plaster or gypsum boards shall be attached for each 10 square feet of area.
- C NC N/A EDGES: The edges of integrated suspended ceilings shall be separated from enclosing walls by a minimum of 1/2".
- C NC N/A SEISMIC JOINT: The ceiling system shall not extend continuously across

any seismic joint.

A XIII.5 Cladding System

- | | |
|----------|---|
| C NC N/A | CLADDING ANCHORS: Cladding components weighing more than 10 psf shall be anchored to the exterior wall framing at a spacing equal to or less than 4 ft. |
| C NC N/A | CLADDING ISOLATION: For moment frame buildings, panel connections shall be detailed to accommodate a drift ratio of 0.01. |
| C NC N/A | DETERIORATION: There shall be no evidence of deterioration or corroding in any of the connection elements. |
| C NC N/A | DAMAGE: There shall be no damage to exterior wall cladding. |

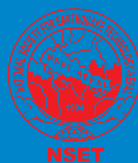

National Society for Earthquake Technology-Nepal

1133 Devkota Sadak, Kha 2-731, Mahadevsthan, Baneshwor, P.O.Box: 13775, Kathmandu, Nepal
Tel: 977-1-4474192, Fax: 977-1-4490943, e-mail: nset@nset.org.np